



**User's Guide**  
**Motion C5**  
**Motion F5**

© 2008 Motion Computing, Inc. All rights reserved.

This document contains information protected by copyright. No part of this document may be reproduced in any form without written consent from Motion.

The information in this document is provided "as is" and is subject to change without notice. Motion is not liable for errors or omissions in this document.

Motion, Motion Computing, Speak Anywhere, and View Anywhere are trademarks or registered trademarks of Motion Computing, Inc. in the U.S.A. and other countries.

Acrobat is a registered trademark of Adobe Systems Incorporated.

Atheros, the Atheros logo, Super G, Super A/G, Wake-on-Wireless, and Wake-on-Theft are registered trademarks of Atheros Communications, Inc.

AuthenTec is a registered trademark of AuthenTec, Inc.

Bluetooth is a registered trademark owned by the Bluetooth SIG, Inc., U.S.A. and licensed to Motion Computing, Inc.

Intel, Intel Inside, the Intel Inside logo, Pentium, Centrino, and PROSet are trademarks or registered trademarks of Intel Corporation or its subsidiaries in the United States and other countries.

Knowles and IntelliSonic are trademarks or registered trademarks of Knowles Acoustics, Inc.

OmniPass is a trademark of Softex, Inc.

Wi-Fi is a registered trademark of the Wi-Fi Alliance.

Microsoft Windows, Windows Vista, Windows XP, Windows XP Tablet PC Edition, and Windows Journal are trademarks or registered trademarks of Microsoft Corporation in the United States and/or other countries.

SigmaTel is a registered trademark and Universal Jacks is a trademark of SigmaTel Corporation.

End users may not loan, rent, lease, lend, or otherwise transfer the CDs or DVDs provided for recovery purposes to another user, except as permitted in the End User License Agreement for such product.

Model numbers C5 (CFT-001) and F5 (CFT-002)  
PN 024-02-0086  
Revision A02  
July 2008

This product incorporates copy protection technology that is protected by U.S. and foreign patents, including patent numbers 5,315,448 and 6,836,549, and other intellectual property rights. The use of Macrovision's copy protection technology in the product must be authorized by Macrovision. Reverse engineering or disassembly is prohibited.

Motion Computing, Inc. has made every effort to identify trademarked properties and owners on this page. All brands and product names used in this document are for identification purposes only and may be trademarks or registered trademarks of their respective companies.

The warranties for Motion products are set forth in the express limited warranty statements accompanying such products. Nothing in this document constitutes an additional warranty.

The Motion Computing products and services may be covered by one or more patent-protected inventions. Additional patents may also be pending. For more information, see [www.motioncomputing.com/info/patents.asp](http://www.motioncomputing.com/info/patents.asp).

The end user may access only one operating system language version.

L'utilisateur final ne peut accéder qu'à une seule version linguistique du système d'exploitation.

Der Endbenutzer darf nur auf eine Sprachversion des Betriebssystems zugreifen.

De eindgebruiker heeft slechts toegang tot één taalversie van het besturingssysteem.

L'utente finale può accedere a una sola lingua del sistema operativo.

El usuario final sólo podrá acceder a una versión de idioma del sistema operativo.

Loppukäyttäjä voi käyttää vain yhtä käyttöjärjestelmän kieliversiota.

Användaren har endast tillgång till en språkversion av operativsystemet.

Slutbrugeren har kun adgang til ét af operativsystemets sprogversioner.

Sluttbruker kan aksessere kun én av operativsystemets språkversjoner.

# Contents

<b>Chapter 1 Getting Started</b> .....	<b>1</b>
Finding information .....	1
Overview .....	2
Front .....	2
Right side .....	3
Top side .....	3
Back side .....	4
Setting up the system .....	5
Restoring and backing up the tablet .....	7
<b>Chapter 2 Features</b> .....	<b>9</b>
Pen .....	10
Status lights .....	10
Front panel buttons .....	11
Display .....	12
Security .....	12
Windows Security button .....	13
Fingerprint reader .....	13
DataGuard .....	14
Camera .....	14
Bar code scanner (optional) .....	15
RFID reader .....	16
Microphones .....	16
Speaker .....	16
Docking connector .....	16
Wi-Fi (802.11a/b/g wireless) .....	17
Broadband Wireless .....	17
Bluetooth wireless .....	17
Battery .....	18
Power adapter .....	18
<b>Chapter 3 Using the system</b> .....	<b>19</b>
Using Motion Dashboard .....	20
Using the pen .....	21
Using Tablet PC Input Panel .....	21
Configuring pen options .....	22
Enabling personalized handwriting recognition .....	23
Using personalized handwriting recognition .....	23
Configuring front panel buttons .....	24
Using the display .....	25
Adjusting the display brightness .....	25
Changing the screen orientation .....	25
Changing the display rotation sequence .....	26
Using the bar code scanner .....	27

Using the RFID reader .....	28
Using the camera .....	29
Using the built-in microphones .....	30
Setting up the angle of acceptance .....	30
Setting up the skew angle .....	31
Using speech recognition .....	31
Speech recognition on Windows Vista .....	32
Speech recognition on Windows XP .....	33
Using the battery. ....	34
Checking battery power .....	34
Charging the battery .....	35
Removing and replacing the battery .....	35
Swapping the battery .....	36
Long-term battery storage (not attached to tablet) .....	36
Battery and power management tips .....	36
Disposing of used batteries .....	37
Using power management .....	37
Power management on Windows Vista .....	37
Using Sleep .....	37
Using Hibernate .....	38
Power management on Windows XP .....	38
Using Standby .....	38
Using Hibernate .....	39
Using Wi-Fi (802.11 a/b/g) .....	39
Enabling or disabling Wi-Fi .....	39
Setting up a Wi-Fi connection on Windows Vista .....	40
Setting up a Wi-Fi connection on Windows XP .....	40
Using Broadband Wireless .....	41
Activating your Broadband Wireless service .....	41
Enabling Broadband Wireless .....	41
Installing the connection manager .....	41
Starting the connection manager .....	42
Connecting and disconnecting .....	42
Using the SIM card slot .....	42
Using Bluetooth .....	44
Enabling or disabling Bluetooth .....	44
Setting up a Bluetooth device on Windows Vista .....	44
Setting up a Bluetooth device on Windows XP .....	45
Using Motion OmniPass and the fingerprint reader .....	48
Capturing a fingerprint .....	48
Using password replacement .....	51
Using the password wizard .....	51
Logging on to a remembered site .....	52
Setting up strong logon security .....	52
Using Windows Security Center .....	53
Setting up users and passwords .....	53
Setting up Windows user accounts .....	53
Setting a BIOS password .....	54
Setting up a hard disk drive password .....	54
Finding additional software .....	55

<b>Chapter 4 Care and Maintenance</b> .....	<b>57</b>
General care.....	57
Standard display .....	58
View Anywhere display.....	58
Cleaning in a health care environment .....	59
Disinfecting procedures .....	59
Training and documentation considerations .....	60
Cleaning solutions.....	60
Cleaning the fan cover.....	60
Cleaning the fingerprint reader .....	61
Pen .....	61
Replacing pen tips.....	62
Ordering new pens.....	62
Traveling with the system .....	62
Traveling by air.....	63
FAA Wireless air travel requirement .....	63
Restoring data.....	63
Using Acronis True Image in Windows .....	63
Using Acronis Startup Recovery Manager .....	64
Creating a backup archive .....	64
Creating a bootable disk.....	64
Removing the Acronis OEM Zone .....	65
<b>Appendix A Troubleshooting and Support</b> .....	<b>67</b>
Troubleshooting .....	67
Frequently asked questions.....	71
Specifications .....	72
Warranty and insurance programs .....	72
Service and support .....	73
<b>Index</b> .....	<b>75</b>



# Getting Started

# 1

The Motion™ C5 and Motion™ F5 are portable, semi-rugged pen-based computers designed for health care, manufacturing, utilities, warehousing, field service workers, or anyone else that needs the mobility and flexibility of a tablet computer.

The C5 and F5 integrate traditional computer features with digital ink, data capture, and speech recognition. The C5 and F5 differ from convertible and slate devices in the following ways:

- Minimize ports and connectors, creating a semi-sealed device that is easier to clean and disinfect.
- Include several built-in data capture technologies—such as a RFID reader, camera, and bar code scanner—that eliminate the need for external devices.
- Deliver an optimal balance of performance and portability.

If you have never used a pen-based computer, use the information in this section to get started. If you are already familiar with pen-based computers, skip to the next chapter to learn about the features of the C5 and F5.

**Note:** Because you typically use a pen instead of a mouse with tablet computers, we use the term *tap* instead of *click* in most situations.

## Finding information

If you are viewing this PDF document on the screen, you can use the following methods to find information:

- In the Bookmark pane, click or tap a topic to view it. If the Bookmark pane is not visible, select **View > Navigation Tabs > Bookmarks**.
- On the Contents page, click or tap a topic to view it.
- To search the document, select **Edit > Find**.

For safety information, see the *Safety and Regulatory Guide* packaged with the unit.

# Overview

The following illustrations show the features of the system.

## Front

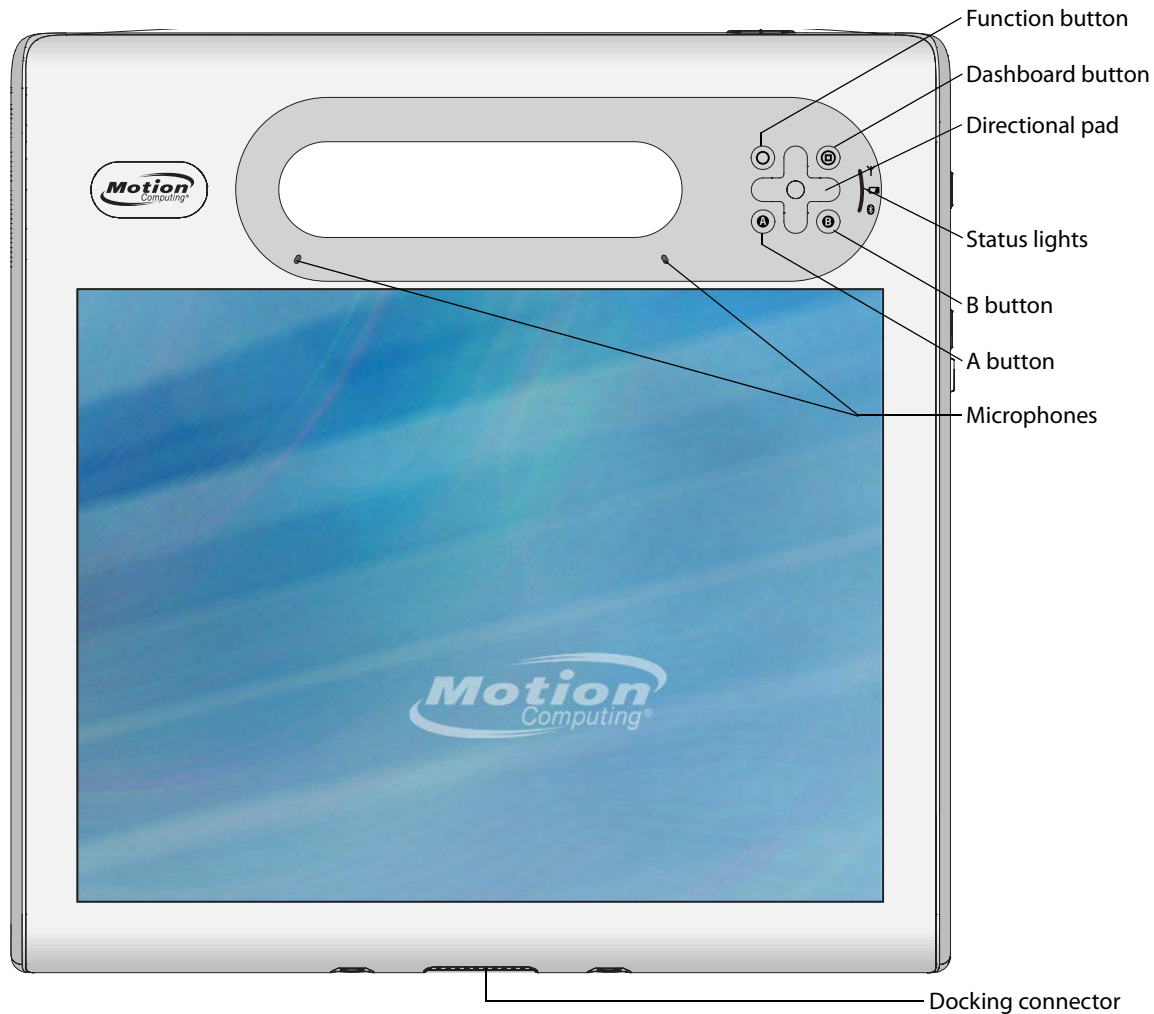





Ⓞ	Function button	Activate secondary functions for other buttons (page 11).
Ⓧ	Dashboard button	Open Motion Dashboard (page 11).
	Directional pad	Use for basic navigation. Equivalent to the arrow keys on a keyboard. The center button is equivalent to Enter (page 11).
Ⓐ	A button	Set up a custom action (page 11).
Ⓑ	B button	Set up a custom action (page 11).
	Status lights	Show wireless, battery, and Bluetooth status (page 10).
	Microphones	Record sounds and use for speech recognition (page 16).
	Docking connector	Interface for the Docking Station.

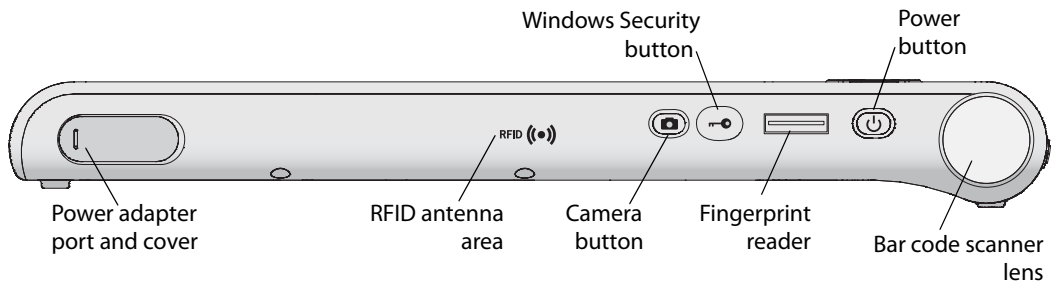



## Right side

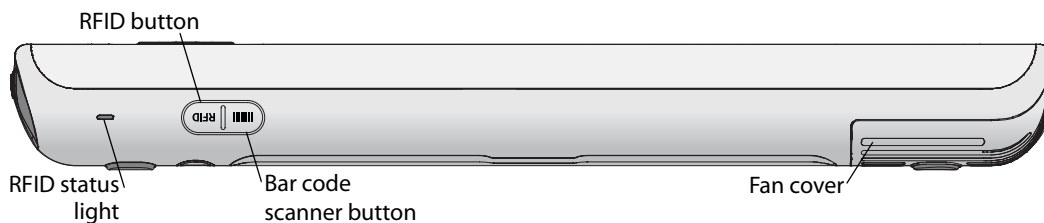

	Power adapter port and cover	Connect the power adapter (page 19).
	RFID antenna area	Scan area for reading RFID tags (page 16).
	Camera button	Use to trigger the built-in camera (page 14).
	Windows Security button	Use to log on to or lock the system. Equivalent to Ctrl+Alt+Del on a keyboard (page 13).
	Fingerprint reader	Scan your fingerprints for added security. You can also use the fingerprint reader as a navigation device (page 13).
	Power button	Turns the system on and off.
	Bar code scanner lens	Reads codes from bar code labels (page 15).

## Top side



	RFID status light	Shows the status of the RFID scanner.
	RFID scanner button	Use to trigger the RFID scanner (page 16).
	Bar code scanner button	Use to trigger the bar code reader (page 15).
	Fan cover	Protects the fan assembly.

## Back side

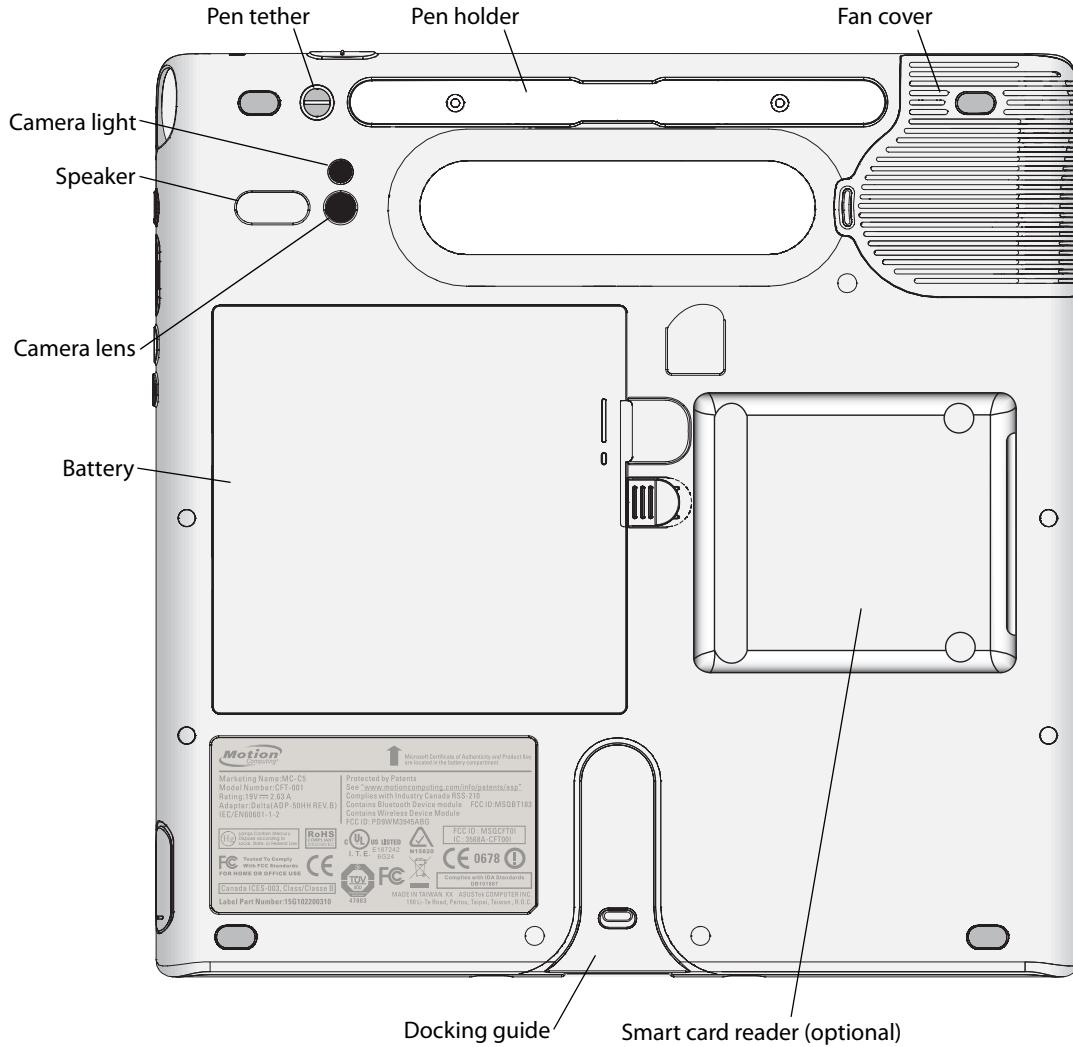

Pen tether	Attach the pen tether.
Pen holder	Store the pen when not in use (page 10).
Fan cover	Protects the fan assembly.
Camera lens	Capture images to the hard disk drive (page 14).
Camera light	Provides light for the built-in camera.
Speaker	Listen to audio (page 17).
Battery	Powers the system when it is not plugged in or docked (page 18). <b>Note:</b> The Microsoft Windows Certificate of Authenticity is under the battery.
Docking guide	Aligns the unit with the Docking Station.
Smart card reader (optional)	Reads and writes information on a smart card that is inserted into the reader.

## Setting up the system

The tablet is self-contained, so you can start using it immediately. If you are using a Docking Station, refer to the instructions that came with the docking station. Use the following steps to get started.

For safety information, see the *Safety and Regulatory Guide* packaged with the system.

### Step 1: Plug in the power adapter

- Plug the power cord into the power adapter and the tablet, then plug the power cord into an outlet.

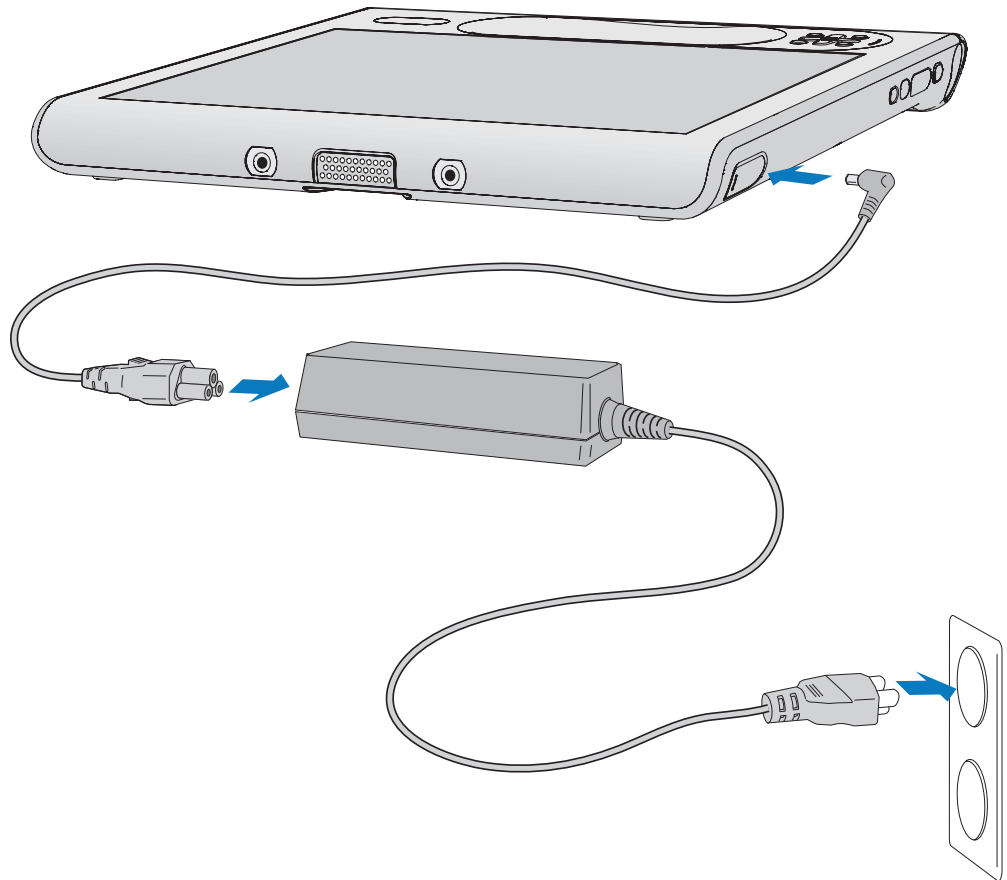

**Note:** You should keep the system plugged in until the battery is fully charged.

### Step 2: Turn on the system

- Press the power button.

As the system starts, the light on the power button comes on.

**Windows Vista.** The first time Windows starts, the Windows Vista Welcome Center appears. If you do not want this screen to appear every time you start the computer, clear the **Run at startup** check box. To return to the Welcome Center later, go to System and Maintenance in Control Panel.

**Windows XP.** The first time Windows starts, the Windows XP Tablet PC Edition 2005 Tutorials appear. If you do not want this screen to appear every time you start the computer, select **Do not show me this again**. To run the tutorials later, select **Start > All Programs > Tablet PC > Tablet PC Tutorials**.

### Step 3: Calibrate the digitizer

With tablet PCs, you will frequently use a pen instead of a mouse and keyboard to interact with the computer. Use the pen to move the pointer around the screen, and tap the screen to click. Use Tablet PC Input Panel to enter text (page 21).

The digitizer detects the position of the pen on the screen. You should calibrate the digitizer the first time you start the system, and again whenever the pointer does not align with the pen tip.

#### To calibrate the digitizer

1. Press the Dashboard button () to start Motion Dashboard.

You can use Motion Dashboard to configure the system and to start commonly used applications. See “Using Motion Dashboard” on page 20.

2. Tap the **Pen & Tablet** tab.
3. Tap **Calibrate Digitizer**.
4. Follow the instructions in the calibration program.

**Note:** If you are left-handed, see “How do I adjust the system for left-handed use?” on page 72.

### Step 4: Get familiar with the system

You can use the Windows Tablet PC tutorials to learn about the tablet computing capabilities of Windows, such as pen support, touch screen support, digital ink input, and handwriting recognition.

To start the tutorials, make one of the following selections:

- In Windows XP:

**Start > All Programs > Tablet PC > Tablet PC Tutorials**

- In Windows Vista:

**Start > All Programs > Tablet PC > Tablet PC Pen Training**

**Start > All Programs > Tablet PC > Pen Flicks Training**

## Restoring and backing up the tablet

For information about restoring and backing up the tablet, see the following sections:

- “Restoring data” on page 63.
- “Creating a backup archive” on page 64
- “Creating a bootable disk” on page 64
- “Removing the Acronis OEM Zone” on page 65



# Features

# 2

Motion Computing tablet PCs provide the power and features of a traditional computer, while giving you the added mobility and versatility of a portable computer.

Use the information in this chapter to get more familiar with the hardware features of the system, such as the buttons, camera, RFID reader, bar code scanner, and wireless adapters.

The system includes the following features:

- Intel® Centrino® Mobile Technology
- Intel® Core™ Solo Processor U1400 1.2 GHz
- Mobile Intel® 945GM Express Chipset
- DDR2 533 MHz SDRAM
- 64-MB or 256-MB video RAM with Intel Dynamic Video Memory Technology
- 10.4" XGA TFT LCD with 1024 x 768 native resolution
- Intel Display Power Saving Technology
- Integrated Wi-Fi (802.11a/b/g) networking
- Integrated Bluetooth®
- Integrated Mobile Broadband (optional)
- Integrated fingerprint reader
- Integrated 2.0 megapixel camera
- Integrated 1D/2D Barcode reader (optional)
- Integrated 13.56-MHz passive RFID reader
- Integrated 13.5-6MHz high-frequency passive RFID tag
- Smart card reader (optional); ISO 7816 PC/SC compliant, contact type smart card reader/writer

## Pen

An important difference between traditional PCs and tablet PCs is that you frequently use a pen instead of a mouse and keyboard to interact with the computer. The pen includes a pressure-sensitive tip, a function button, and an eraser. The pen contains no batteries and requires no external power.

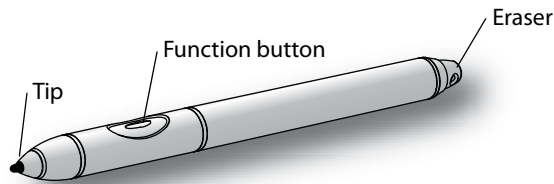

For information about using the pen, see “Using the pen” on page 21.

## Status lights

You can use the indicator lights on the front of the unit to monitor the status of the system. The following illustration shows the status lights.

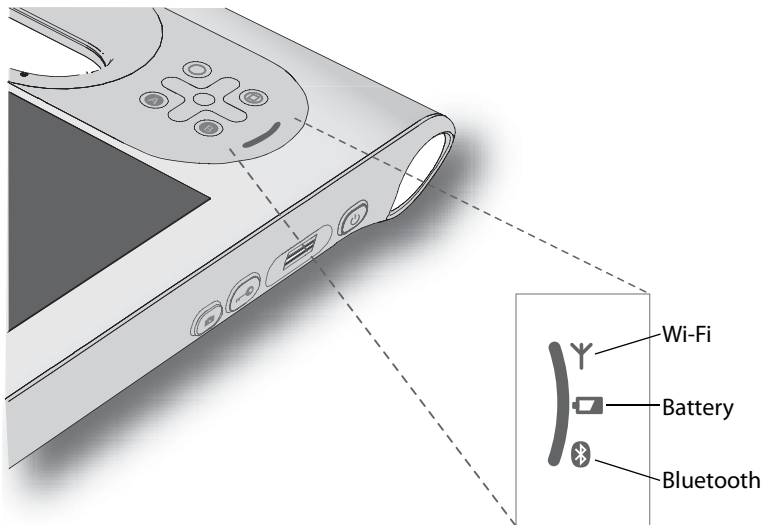

Light	Status	Description
Wi-Fi	Steady green	The Wi-Fi (802.11 a/b/g) adapter is enabled
Battery	Steady amber	The battery is charging
	Steady green	The battery is fully charged
	Flashing amber (slow)	10% charge remaining
	Flashing amber (fast)	Less than 5% charge remaining
Bluetooth	Steady green	The Bluetooth adapter is enabled



## Front panel buttons

You can use the buttons on the front of the unit to perform many functions without having to use the pen. The buttons are customizable, so you can modify their functions to suit the way you work. See “Configuring front panel buttons” on page 24.

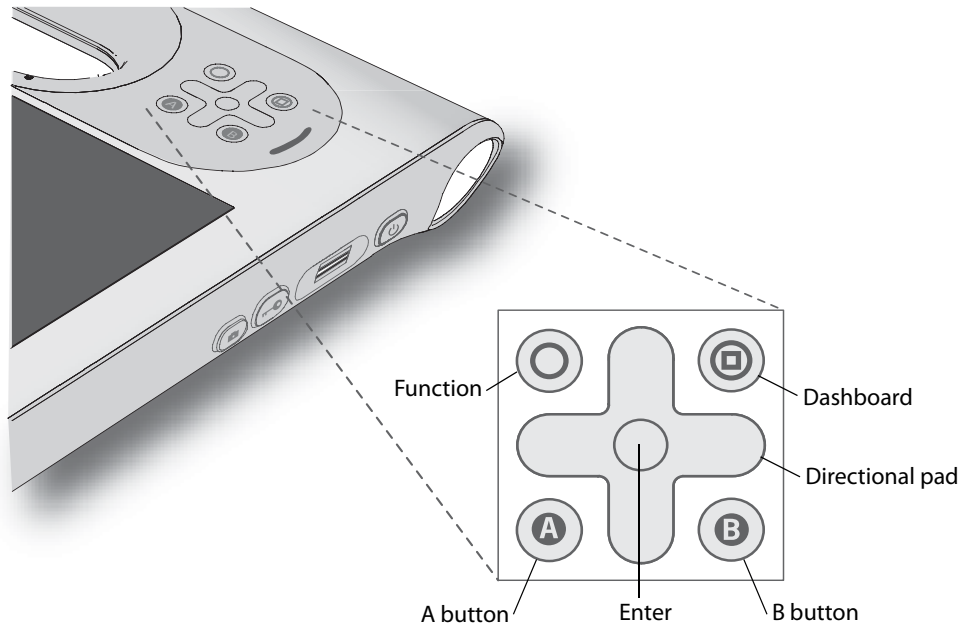

Button	Primary	Secondary (Function+button)
Function	Activates secondary function for other buttons	N/A
Dashboard	Starts Motion Dashboard	Starts Windows Journal
Directional pad	Use to move the pointer or navigate through documents. Equivalent to arrow keys on a keyboard.	Left = Shift+Tab Right = Tab Up = Page Up Down = Page Down
Enter	Makes a selection. Equivalent to the Enter key on a keyboard.	Windows logo key
A	Application specific	Rotates the display orientation.
B	In the default setting, the button activates the bar code scanner. If the button is reset, it becomes application-specific.	Cancels the current task. Equivalent to the Esc key.

The directional pad orientation rotates to match the display orientation. To move the pointer in a certain direction, press that direction on the pad regardless of orientation. For example, “up” in landscape orientation becomes “left” in portrait orientation.

## Display

The system includes a 10.4" XGA TFT LCD display with the following features:

- A highly readable LCD (liquid crystal display) with a wide viewing angle.
- 1024 x 768 native resolution.
- Intel Display Power Saving Technology.
- A protective layer that offers a firm writing surface and minimizes glare.
- A digitizer panel that enables handwritten entry with the pen.

The optional View Anywhere™ display enhances outdoor viewing and bright-light indoor viewing. The View Anywhere display includes all the features of the standard display, while adding increased sunlight contrast ratio, increased brightness, and decreased glare.

## Security

Your system includes several features that you can use to enhance the security of your data and serve as the foundation for complementary security technologies. The core security features include password-protected Phoenix TrustedCore BIOS with HDD locking and networking control, optional ComputraceComplete tracking software, a built-in fingerprint reader, Dashboard Security Center, and TPM (Trusted Platform Module) 1.2.

With TPM and the Infineon Security Platform Tools, you can create and manage digital certificates for user and platform authentication. These features are most commonly used by enterprises and are typically set up by the system administrator. To learn more about TPM, go to [www.motioncomputing.com/support/support\\_documentation.asp](http://www.motioncomputing.com/support/support_documentation.asp).

The optional ComputraceComplete solution offers Computer Theft Recovery, Data Protection, Secure Asset Tracking and a Recovery Guarantee.

## Windows Security button

You can use the Windows Security button to log on to or lock the system. Pressing the Windows Security button is equivalent to pressing Ctrl+Alt+Del on a keyboard.

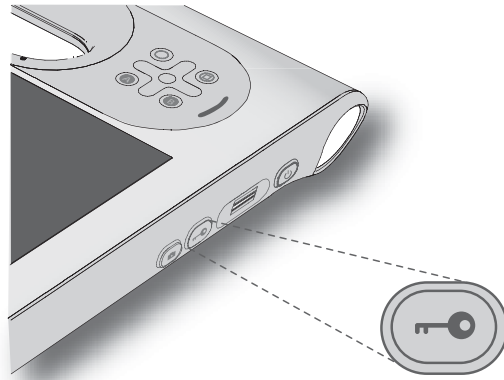

## Fingerprint reader

Using the fingerprint reader, you can log on to the system by scanning your fingerprint instead of entering a password. This feature presents another level of security for the system.

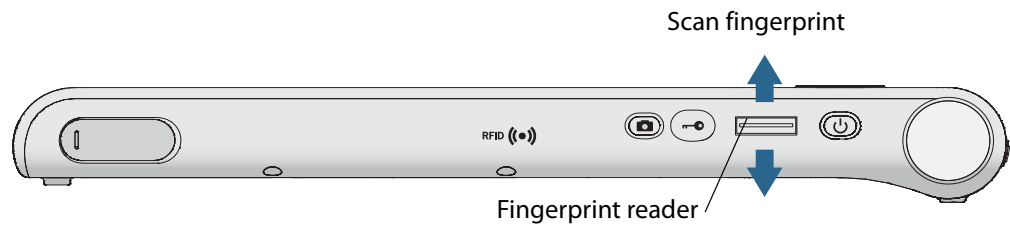

You can use the OmniPass application to associate your fingerprint with passwords for Web pages and other applications. For information about setting up and using the fingerprint reader, see "Capturing a fingerprint" on page 49.

## DataGuard

Your system includes the DataGuard feature, which detects shocks, extreme vibrations, and falls. If a fall, shock, or vibration is detected, DataGuard moves the drive heads away from the disk, which can prevent hard drive failures and data loss. For more information, go to Control Panel and open DataGuard.

## Camera

You can use the built-in 2-megapixel auto-focus camera to take pictures and save them to the hard disk drive. The camera lens is on the back of the unit, and includes a light to illuminate the subject. The camera produces pictures in BMP format with a resolution up to 1600 × 1200 pixels.

The following table shows detailed specifications for the camera.

Item	Value
Sensor array	CMOS sensor 2.0 megapixel
Pixel size	3.0µm x 3.0µm
Optical format	1/3"
S/N ratio	40dB
F number	2.8
Focus	Auto focus @ 10cm ~ infinity
Image resolution	1600 x 1200 1280 x 1024 1024 x 768 800 x 600 640 x 480 320 x 240
Frame rate	2M @ 11fps: 1.3M @ 15fps VGA @ 30fps QVGA @ 30fps (MJPEG mode)
White balance	Automatic
Exposure	Automatic

For information about using the camera, see “Using the camera” on page 29.

## Bar code scanner (optional)

The system is available with an optional integrated 1D and 2D bar code scanner that you can use to retrieve information from bar codes.

A bar code is a series of shapes on a contrasting background that can be optically read by a bar code scanner. Bar codes can be used for asset tracking, identification, process control, health care and pharmaceutical applications.

The following symbologies are enabled by default:

- Aztec Code
- Code 128
- EAN-128
- EAN-UCC-CC-AB
- Code 39
- DataMatrix
- UPC-A
- UPC-E
- EAN-8
- EAN-13
- Interleaved 2 of 5
- PDF417
- Micro PDF417
- RSS-14
- RSS Limited

You can configure the bar code scanner to read the following symbologies. For information about configuring the bar code scanner, go to the Motion Knowledge Base Web page at [www.motioncomputing.com/kb/](http://www.motioncomputing.com/kb/) and search on “symbologies”.

- Codabar
- Codablock A
- Codablock F
- EAN-UCC-CC-C
- Code 93
- UPC-E1
- EAN ISBN
- EAN-ISMN
- EAN ISSN
- MSI
- MaxiCode
- Plessey Code
- QR Code
- RSS Expanded
- TLC 39
- Straight 2 of 5 TwoBar
- Telepen
- Code 11
- Australia Post
- BPO\*
- Dutch Post
- Japan Post\*
- Planet
- Postnet\*

\*These symbologies are special cases and, if enabled, may interfere with the scanner’s ability to scan other Code128 barcode types, such as:

- CIP 128
- EAN-128 Irregular
- ISBT-128

For more information about the bar code scanner, see “Using the bar code scanner” on page 27.

## RFID reader

Your system includes an integrated 13.56 MHz RFID (Radio Frequency Identification) reader that you can use to retrieve information from RFID tags.

RFID tags use radio frequency (RF) transmissions to identify a product, animal, or person. RFID does not require direct contact or line-of-sight scanning, and can be scanned through many materials, including clothing. An RFID tag can store much more data than a typical bar code, and some RFID tags can both transmit and record data. RFID can be used for asset tracking, identification, process control, health care, and pharmaceutical applications.

The RFID reader supports the following formats:

- ISO/IEC 14443A/B
- ISO/IEC 15693
- ISO/IEC 18000-3

For information about using the RFID reader, see “Using the RFID reader” on page 28.

The system also includes an integrated 13.56MHz high-frequency passive RFID tag that can be used for identification and short-range asset tracking. The tag is located on the back of the tablet, below the battery, and under the FCC label.

## Smart card reader

Your tablet may include the optional smart card reader located on the back of the tablet, next to the battery. Using smart card software, this device can read information from and write information to the smart card when the card is inserted into the reader. The smart card is an ISO 7816 PC/SC compliant, contact type smart card reader/writer.

For information about using the smart card reader, see “Using the smart card reader (optional)” on page 30.

## Microphones

The system is equipped with two liquid-resistant microphones that you can use to record audio, dictate notes, and use voice commands without the need for an external microphone.

For information about using the microphones, see “Using the built-in microphones” on page 31.

## Speaker

The system includes a sealed speaker that can be used for audio warnings or confirmation, dictation, videos, or other multimedia applications.

## Docking connector

The docking connector is used to attach the unit to a docking station. When the unit is docked, you can use the ports on the docking station to connect a monitor, keyboard, mouse, or other external USB devices.

For more information about the Docking Station and other accessories, go to the Motion Computing accessories page at [www.motioncomputing.com/accessories](http://www.motioncomputing.com/accessories).

## Wi-Fi (802.11a/b/g wireless)

You can use the integrated Wi-Fi (802.11a/b/g) adapter to connect to the Internet and other computers wirelessly. You can use Wi-Fi in many schools, hospitals, clinics, airports, and hotels.

**Note:** Wireless access requires an 802.11a, 802.11b, or 802.11g access point. Internet access requires a working Internet connection.

Your ability to use Wi-Fi depends on several conditions:

- Distance from the access point.
- Ability to connect to the access point.
- Access rights, which may require a user name and password.
- Security settings, such as whether the network broadcasts a network name or uses encryption.

For more information, see “Using Wi-Fi (802.11a/b/g)” on page 40.

## Mobile Broadband

Some tablet models are available with an optional Mobile Broadband adapter that you can use to send and receive data wirelessly. By using Mobile Broadband, you can browse the Internet, send and receive email, connect to your company's intranet, and use Web-based applications. You can typically use Mobile Broadband anywhere you can use your mobile phone.

Mobile Broadband is based on cellular network technology, so you can use it in more places than other wireless technologies. With Mobile Broadband, your Tablet PC connects to a service provider's base station, which in turn is connected to the Internet. Unlike Wi-Fi, you do not need to buy base stations or search for Wi-Fi hotspots. For more information, see "Using Mobile Broadband" on page 42.

## Bluetooth wireless

The system has an integrated Bluetooth adapter. With Bluetooth, computers and other devices—such as mice, keyboards, and PDAs—can be interconnected using a short-range wireless connection. Bluetooth devices can connect wirelessly at distances up to 33 feet (10 meters).

For more information, see "Using Bluetooth" on page 45.

## Battery

The system includes a high-capacity Lithium-ion battery that fits in to the back of the unit. Under normal conditions, you can run the system on battery power for about three hours. You can maximize battery life by optimizing your power scheme. See "Using power management" on page 38.

For information about charging and checking battery status, see "Using the battery" on page 35.



**DANGER:** To avoid personal injury, handle the battery with care. Do not open, puncture, short, or expose it to fire or water. Keep the battery in an environment with ambient temperature of less than 104°F (40°C). For example, do not leave the battery in a closed car in hot weather for an extended time. For more information, see the *Safety and Regulatory Guide* packaged with the system.



## Power adapter

The power adapter provides power to the system and charges the battery when it is attached. The power adapter includes a power cord and an AC adapter.



**WARNING:** Use only the Motion power adapter with the system. Do not use the adapter to power any other electronic devices.



# Using the system

# 3

The Motion C5 and Motion F5 run Windows Vista or Microsoft Windows XP Tablet PC Edition, which include ink-to-text and word recognition, voice recognition, and security features to help defend against viruses, worms, and other threats. And unlike PDAs or other handheld devices, the C5 and F5 run any Windows-compatible application.

Use the information in this chapter to learn about common tasks, such as using the pen to enter text, using Motion Dashboard, using speech recognition, and customizing the tablet to fit the way you work.

# Using Motion Dashboard

Motion Dashboard puts many common settings and tasks at your fingertips. For example, you can enable or disable Bluetooth and Wi-Fi, calibrate the digitizer, or check the remaining battery power.

## To start Motion Dashboard

- Press the Dashboard button ((Ⓜ)) on the front of the unit.

To open a category, tap the appropriate icon on the left side.



When you change a setting on Motion Dashboard, the change occurs immediately. You do not need to tap **Apply** or **OK**.

For more information, see Motion Dashboard Help.

## Using the pen

You can use the pen to write on the display and interact with the operating system. A pen can feel more natural in your hand than a mouse, and you can use the pen while standing or walking. The following table shows various mouse actions and their pen equivalents.

Mouse action	Pen equivalent
Point	Point
Click	Tap
Double-click	Double-tap
Drag	Drag
Right-click	Tap and hold
Right-click	Press Function button and then tap

You can use Tablet PC Input Panel instead of a keyboard to enter text. For more information, see “Using Tablet PC Input Panel” on page 21.

Some software applications, such as Microsoft Word and Microsoft PowerPoint, support ink drawing and ink annotations. Some applications, such as art or drawing programs, are designed specifically for ink input. For more information about a particular application, open the application help and search for “pen”, “ink”, or “digitizer”.

Store the pen in the pen holder when not in use. To put the pen in the pen holder, press it until it clicks into place. To remove the pen, press down on one end, grab the other end, and remove from the holder.

For information about replacing pen tips, see “Replacing pen tips” on page 62.

**Important:** The system responds to the Motion pen only. Do not use a traditional pen, pencil, or stylus with the system.

## Using Tablet PC Input Panel

You can use Tablet PC Input Panel instead of a keyboard to enter text on the tablet. Use the writing pad or the character pad to convert your handwriting to text, or tap characters using the on-screen keyboard.

### To start Input Panel

- Do one of the following:
  - Tap at the place you want to enter text, such as a text box. Then tap the floating Tablet PC Input Panel icon ().
  - On Windows Vista, tap the Input Panel tab on the left edge of the screen (default).
  - On Windows XP, tap the Tablet PC Input Panel icon on the Windows taskbar.

To switch among the writing pad, the character pad, and the on-screen keyboard, tap the appropriate button.

The following illustration shows Input Panel open to the writing pad.

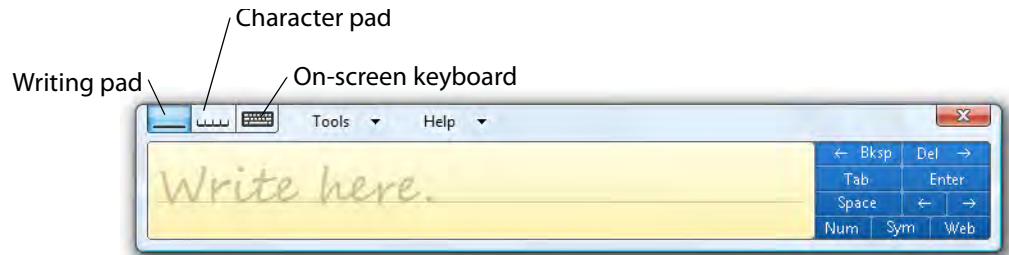

Use the tutorial to get acquainted with Input Panel. Tap **Help**, then tap **Tutorial**. For a demonstration, tap **Help**, then tap **Show me how to enter text** (Windows Vista only).

For more information about using Input Panel, see the Input Panel Help.

You can also use Input Panel to dictate text or use voice commands. For more information about Speech Recognition, see "Using speech recognition" on page 32.

**Note:** Input Panel differs slightly between Windows XP and Windows Vista.

## Configuring pen options

You can use pen options to enable or disable the pen function button and the pen eraser.

### To configure pen options (Windows Vista)

1. Open Motion Dashboard to the Pen & Tablet panel (page 20).
2. Tap the **Pen & Input Devices** button.
3. In the Pen and Input Devices window, tap the **Pen Options** tab.
4. For **Pen buttons**, do one of the following:
  - To enable the function button, select **Use pen button as a right-click equivalent**.
  - To enable the eraser, select **Use the top of the pen to erase ink**.

### To configure pen options (Windows XP)

1. Open Motion Dashboard to the Pen & Tablet panel (page 20).
2. Tap the **Tablet & Pen Settings** button.
3. In the Tablet and Pen Settings window, tap the **Pen Options** tab.
4. For **Pen buttons**, do one of the following:
  - To enable the function button, select **Use pen button to right-click**.
  - To enable the eraser, select **Use the top of the pen to erase**.

## Enabling personalized handwriting recognition

You can use the Tablet PC Settings window to enable personalized handwriting recognition.

**Note:** This feature is available on Windows Vista only.

### To enable personalized handwriting recognition

1. Open Motion Dashboard to the Pen & Tablet panel (page 20).
2. Tap the **Tablet PC Settings** button.
3. In the Tablet PC Settings window, tap the **Handwriting Recognition** tab.
4. Select **Use the personalized recognizer**.

For information on using the handwriting personalization tool, see “Using personalized handwriting recognition” on page 23.

## Using personalized handwriting recognition

After you have enabled personalized handwriting recognition, you can use the handwriting personalization tool to improve your handwriting recognition results.

**Note:** This feature is available on Windows Vista only.

### To use the handwriting recognition personalization tool

1. Open Input Panel (page 21).
2. Tap **Tools**, then tap **Personalize Handwriting Recognition**.
3. Follow the instructions in the handwriting personalization tool.

## Configuring front panel buttons

As you become more familiar with your system, you may want to customize the buttons on the front panel. You can configure the buttons to start your favorite program, run a command, or enter a key combination.

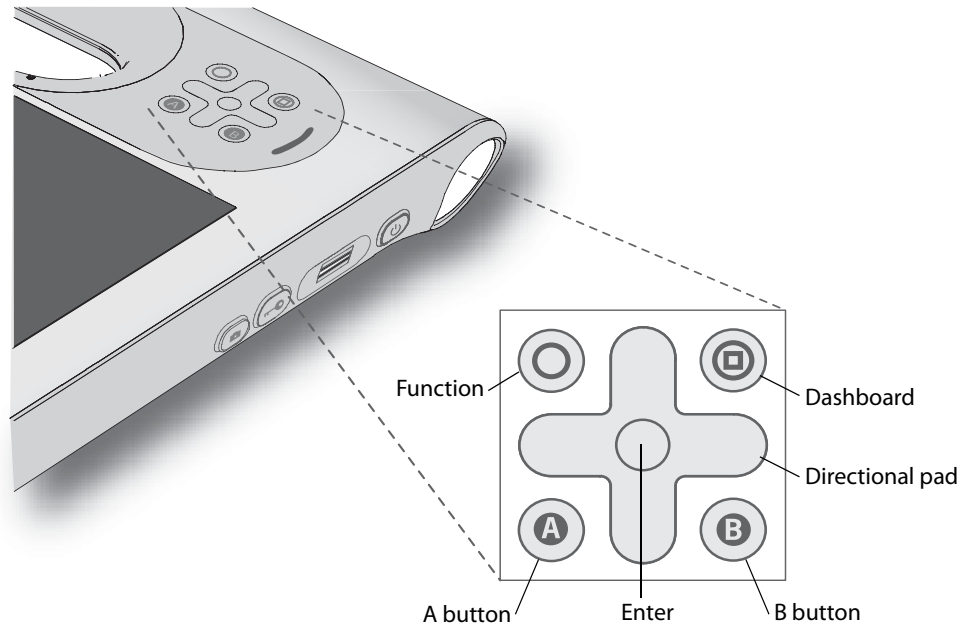

### To configure the front panel buttons (Windows Vista)

1. Open Motion Dashboard to the Pen & Tablet panel (page 20).
2. Tap the **Tablet PC Settings** button.
3. In the Tablet PC Settings window, tap the **Buttons** tab.
4. Select the button combination you want to change. The currently selected buttons appear in red.
5. Tap **Change**.
6. Select the appropriate action for the button.

For some actions, you must enter more information, such as the location of a program to start. You can select an action for **Press** and another for **Press and hold**. For more information, tap **What is press and hold?**

**Note:** To reset the buttons to their default values, tap the **Reset** button.



### To configure the front panel buttons (Windows XP)

1. Open Motion Dashboard to the Pen & Tablet panel (page 20).
2. Tap **Tablet & Pen Settings**.
3. Tap the **Tablet Buttons** tab.
4. Select the button combination you want to change. The currently selected buttons appear in red.
5. Tap **Change**.
6. For **Action**, select an action to assign to the button.

For some actions, you must enter more information, such as the location of a program to start. Tap **Help** for more information.

**Note:** To reset the buttons to their default values, tap the **Reset** button.

## Using the display

Use the information in this section to customize your display settings. You can adjust the brightness level, rotate the display, and change the order in which the display rotates.

### Adjusting the display brightness

Use this procedure to change the brightness of the display.

#### To adjust the display brightness

1. Open Motion Dashboard to the Display panel (page 20).
2. Set the Brightness slider to the desired level for when the tablet is running on AC power and when it is running on battery power. You can select these settings in the **Settings for** pull-down menu and adjust the Brightness slider for each power scheme.

To maximize battery life, set the brightness scale to the dimmest level that you are comfortable with.

## Changing the screen orientation

You can easily change the screen orientation to fit your current task. You may want to use the portrait orientation for filling out forms or reading an e-book. At other times, you may want a landscape orientation for Web browsing or sketching.

You can also use the front panel buttons to change the screen orientation. Press Function+A (page 11).

#### To change the screen orientation

1. Open Motion Dashboard to the Display panel (page 20).

2. Tap **Rotate Screen**.

**Note:** If you change the screen orientation, you may need to recalibrate the pen. See “Calibrate the digitizer” on page 6.

## Changing the display rotation sequence

Use this procedure to change the order in which the display rotates.

### To change the rotation sequence

1. Open Motion Dashboard to the Pen & Tablet panel (page 20).
2. Do one of the following:
  - On Windows Vista, tap the **Tablet PC Settings** button.
  - On Windows XP, tap the **Tablet & Pen Settings** button.
3. Tap the **Display** tab.
4. For Sequence, click **Change**.
5. Select orientations for 1, 2, and 3.

You can select **None** to skip a particular view in the rotation sequence.

## Using the bar code scanner

You can use the built-in bar code scanner to retrieve information from bar codes. For more information about the bar code scanner, see “Bar code scanner (optional)” on page 15.

### To use the bar code scanner

1. Open the application that you want to receive the bar code data and place the insertion point in the appropriate field.
2. Hold the unit by the handle with the scanner lens in front of you.
3. Aim the scanner lens at the bar code.

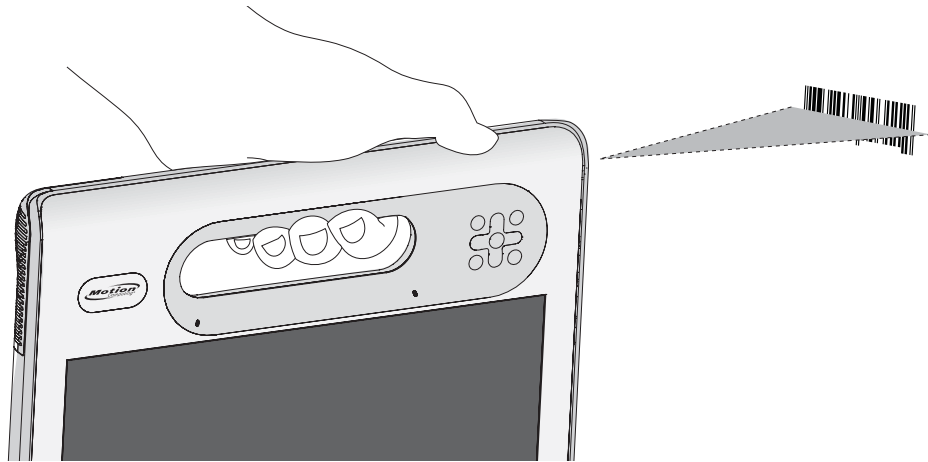

4. Press and release the bar code scanner button on the top of the unit. Ensure that the scan beam covers the entire bar code.

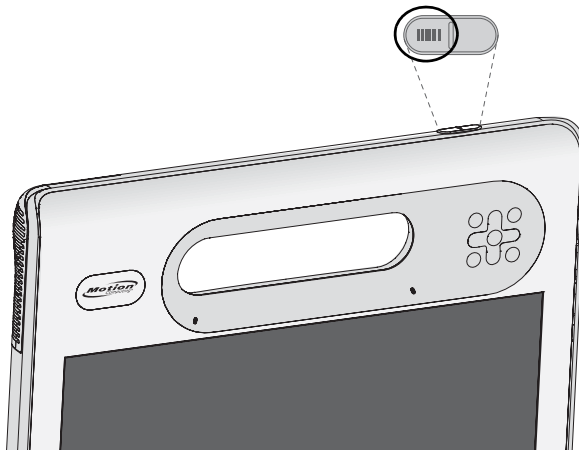

If the scan was successful, the data will appear in the application and you will hear a chime sound as confirmation.

### Bar code scanner tips

- You will typically get the best scans if the lens is six to seven inches from the bar code.
- If you are having trouble scanning a bar code, use two hands to steady the unit while you scan.

## Using the RFID reader

You can use the built-in RFID reader to retrieve information from RFID tags. For more information about the RFID reader, see “RFID reader” on page 16.

### To use the RFID reader

1. Hold the unit by the handle with the right edge in front of you.
2. Aim the right edge of the unit at the RFID tag. Ensure that the tag is 1–1.5 inches (25–40 mm) from the RFID antenna scan area.

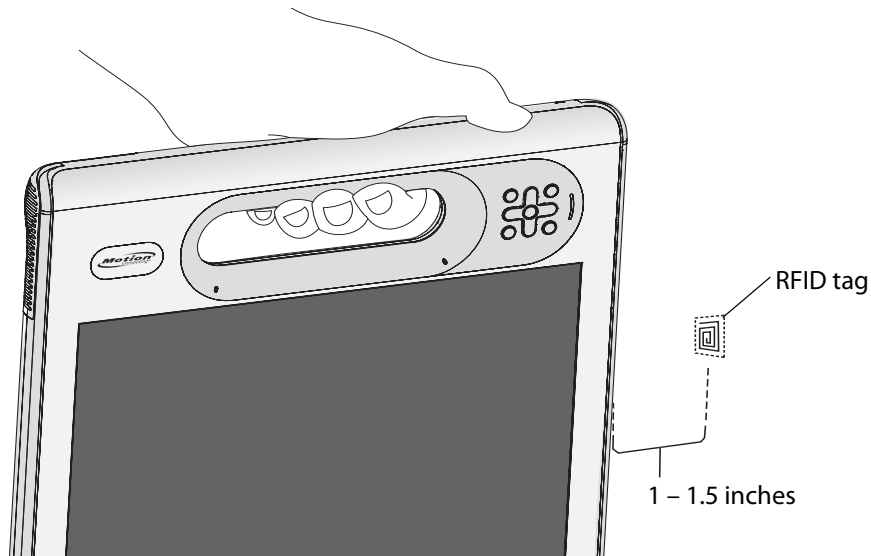

3. Press and release the RFID button on the top of the unit. The RFID light will come on to indicate that the unit is scanning.

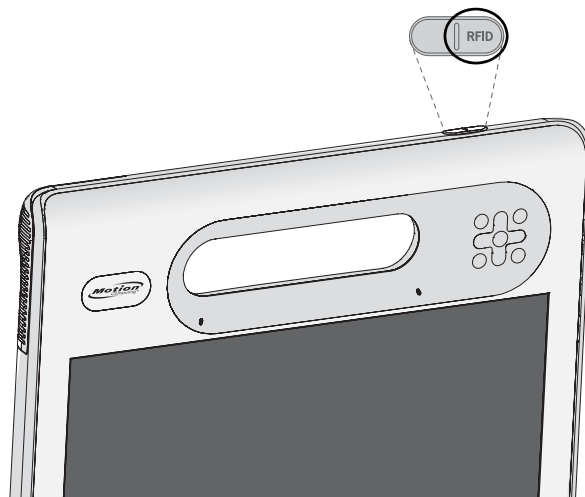

The RFID light goes off and the unit beeps to indicate a successful scan. The ASCII and Hex data appears in the RFID Tag Data window.

**Note:** RFID tags are typically used with specialized applications. See your system administrator for more information.

## Using the camera

You can use the built-in camera to take pictures. For more information about the camera, see “Camera” on page 14.

### To use the camera

1. Press the Camera button to activate the camera and open the viewfinder.

**Note:** If a picture is not taken after a short period, the viewfinder will automatically close. If this occurs, repeat step 1.

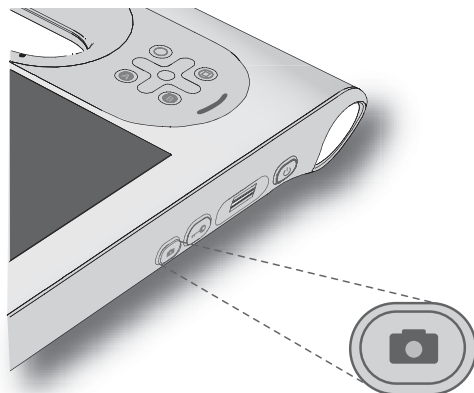

2. Press the Camera button again to take a picture.
3. In the Pictures window, do one of the following:
  - To delete the picture, tap **Delete**. In the confirmation dialog box, tap **Yes**.
  - To copy the picture, tap **Copy to Clipboard**. You can then paste the picture into an image editing program.
  - To close the Pictures window, tap **Close**.
  - To save the picture, tap **Save**. In the Save As dialog box, specify a location in which to save the picture.

### Camera tips

- Hold the camera steady and allow it to focus.
- If your pen is tethered, ensure that the tether is not in front of the camera lens.
- Ensure you have adequate lighting.
- You can use the Pictures window to take and review multiple pictures. Use the slider bar at the bottom of the Pictures window to switch among active pictures.

## Using the smart card reader (optional)

Some tablets contain the optional smart card reader. Using smart card software, this device reads information from the smart card when the card is inserted into the reader.

Depending on the smart card software you are using:

- You may receive an acknowledgement for when the smart card is fully engaged in the reader.
- You may receive a prompt or be required to shut down the software before removing the smart card.
- Some smart cards may require you to insert the smart card for authentication, and then remove the smart card when authentication is completed.
- Some smart cards may require keeping the card in the reader while the smart card software is running.

### To insert the smart card

1. Place the smart card in front of the smart card reader with the metal contacts of the embedded chip facing the back of the tablet.
2. Slide the smart card into the smart card reader until the card is firmly seated in the reader.

### To remove the smart card

1. Depending on your smart card software, you may be required to first shut down the smart card software before removing the card. With this type of software, removing the smart card while the tablet is running can result in logging off or shutting down the tablet.
2. Pull the card straight out of the reader.

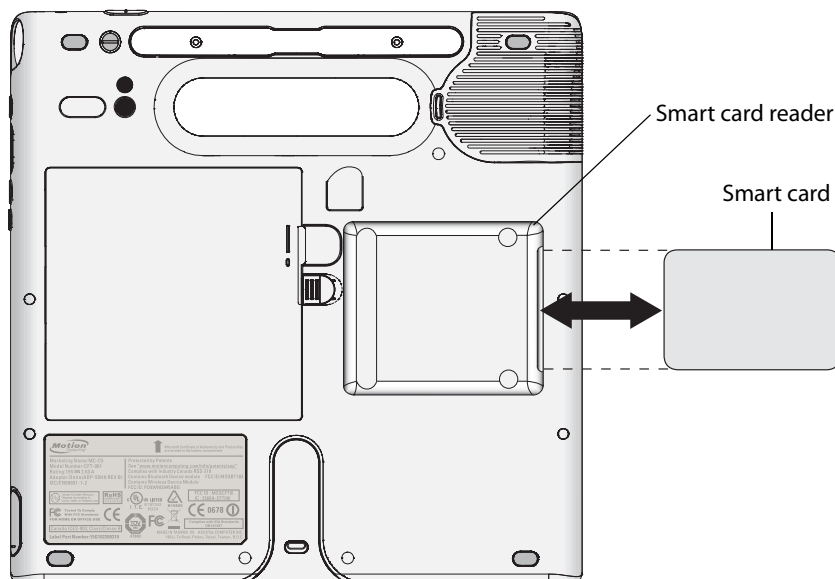

## Using the built-in microphones

You can use the built-in microphones to record audio, dictate notes, and use voice commands. The two microphones are used at the same time to optimize sound detection for speech recognition and voice recording.

You can use the Speak Anywhere acoustics software to fine tune the built-in microphones to suit your environment. The software enables you to use the microphones in a variety of settings, including small or large groups, noisy environments, or for individual dictation or voice commands. The software improves the microphone reception by:

- Removing all sounds outside of the user-defined angle of acceptance.
- Minimizing background and ambient noise.
- Removing echo caused by the microphone picking up the speaker output (feedback).

## Setting up the angle of acceptance

On tablets running Windows XP, the angle of acceptance defines how the built-in microphones detect sounds. When recording, dictating, or using voice commands, you can remove all sounds outside of a specified angle. You may need to adjust this setting until you achieve the desired results.

**Note:** This section applies to tablets running Windows XP only. For tablets running Windows Vista, the angle of acceptance is set automatically.

### To set up the angle of acceptance

1. Open Motion Dashboard to the Audio panel (page 20).
2. Under Microphone, select one of the following:
  - **Narrow angle.** Configures the microphones to detect sound on a narrow angle near the bottom center of the display. Narrow is the best setting for dictation, Voice over IP, or “voice noisy” environments.
  - **Medium angle.** Configures the microphones to detect sound at a wider angle. Medium is the best setting for a small group, conference table, or “voice quiet” environment.
  - **Wide angle.** The microphones detect sound at the widest angle. If the microphones are detecting too much background noise, change to a narrower setting.

If a sound is loud enough, the microphones will pick it up regardless of the angle of acceptance setting.

You can limit the detection of these outside sounds by turning down the microphone level and speaking louder. This reduces the microphones’ range and restricts the capability to detect extraneous sounds.

## Setting up the skew angle

On tablets running Windows XP, the skew angle determines sound detection in the horizontal plane. The default sound detection area is directly in front of the unit, but you can use the skew angle to offset the sound detection area toward one side or the other.

**Note:** This section applies to tablets running Windows XP only. For tablets running Windows Vista, the skew angle is set automatically.

### To set up the skew angle

1. Open Motion Dashboard to the Audio panel (page 20).
2. Under Microphone, ensure that **Narrow Angle** or **Medium Angle** is selected. You cannot use a skew angle with the Wide angle setting.
3. Move to where you want the microphone to detect your voice.
4. Tap **Calibrate**. A block of text appears.
5. Read the text aloud, speaking normally towards the microphones. This process takes about 30 seconds.

In many cases, you will not need to calibrate the built-in microphones because the audio system filters out many unwanted sounds. If you are dictating in an office or recording during a meeting, the audio system may work well with no additional calibration.

**Note:** The audio system does not store calibrations. If you change to another angle or position and then return to the previous one, you must recalibrate the audio system.

## Using speech recognition

You can use speech recognition to interact with your computer by voice. You can dictate documents and emails, or use voice commands to control programs.

- **Dictation mode.** With Dictation mode, the computer listens to everything you say and converts your words to text. You can use dictation mode to enter text directly into any document or text box.
- **Voice command mode.** With Voice command mode, the computer listens for specific words that correspond to a list of available voice commands. You can use commands to switch between programs, save documents, copy, paste, or undo.



## Speech recognition on Windows Vista

Before you can use speech recognition on Windows Vista, you must configure the microphones and train the system for the characteristics of your voice. You can also take the speech tutorial to learn how to talk to your tablet.

### To set up the microphones

1. In Control Panel, open Speech Recognition.
2. Tap **Set up microphone**.
3. If you are using the integrated Tablet PC microphones, select **Other**.
4. Follow the instructions in the setup program.

If the microphones are set to an appropriate level, the meter will stay in the green zone while you read the sentences. If the level is too low or too high, use Motion Dashboard to adjust the microphone levels (page 20).

### To train your computer to recognize your speech

1. In Control Panel, open Speech Recognition.
2. Tap **Train your computer to better understand you**.
3. Follow the instructions in the setup program.

### To take the speech tutorial

1. In Control Panel, open Speech Recognition.
2. Tap **Take Speech Tutorial**.
3. Follow the instructions in the tutorial program.

After you have set up speech recognition, you can start it from Control Panel.

### To use Dictation and Voice Commands

1. In Control Panel, open Speech Recognition.
2. Tap **Start Speech Recognition**.
3. Ensure that the Speech Recognition window is open and listening.

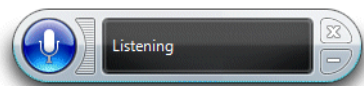

4. Do one of the following:
  - For voice commands, say the appropriate command. For a list of commands, open Windows Help and Support and search for "speech commands".
  - For dictation, open the program you want to use and start speaking.

For more information about speech recognition, open Windows Help and Support and search for “speech recognition”.

## Speech recognition on Windows XP

Before you can use speech recognition on Windows XP, you must configure the microphones and train the system for the characteristics of your voice. The entire process takes about 10 minutes. You should move to a quiet environment before starting this procedure.

### To set up speech recognition

1. Open Motion Dashboard to the Audio panel (page 20).
2. Ensure that the speaker and microphones are set to appropriate levels.
3. Start Input Panel (page 21).
4. Tap the **Tools and Options** button (  ), then tap **Speech**.
5. Tap **Next** and follow the instructions in the setup program.

You can improve speech recognition by running additional speech training sessions. In Control Panel, open Speech.

### To start speech recognition

1. Start Input Panel (page 21).
2. Tap the **Tools and Options** button (  ), then tap **Speech**.
3. Select **Dictation** or **Commands**.

For more information about Dictation and Commands, see the Input Panel Help and the Tablet PC Tutorials.

## Using the battery

The system runs on battery power when it is not plugged in. The battery is located on the back of the unit.

To maximize the performance of the battery, deplete the battery charge to less than 10% every 30 days. To deplete the battery, use the tablet on battery power without AC power until the battery charge is less than 10%.

## Checking battery power

You can check the remaining battery power from Motion Dashboard, from the battery icon in the notification area, or from the battery itself.

### To check the battery power from Motion Dashboard

- Open Motion Dashboard to the Power panel (page 20).

### To check the battery power from the notification area

- Place the pointer over the battery icon in the notification area.

The battery icon shows a graphical representation of the remaining battery power.

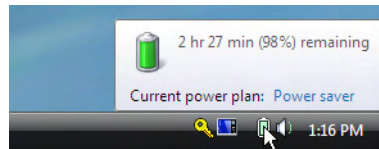

### To check the battery gauge

- Locate the gauge on the back of the battery and press the button.

The indicator lights show the remaining charge. Each light represents approximately 20% of the total charge.

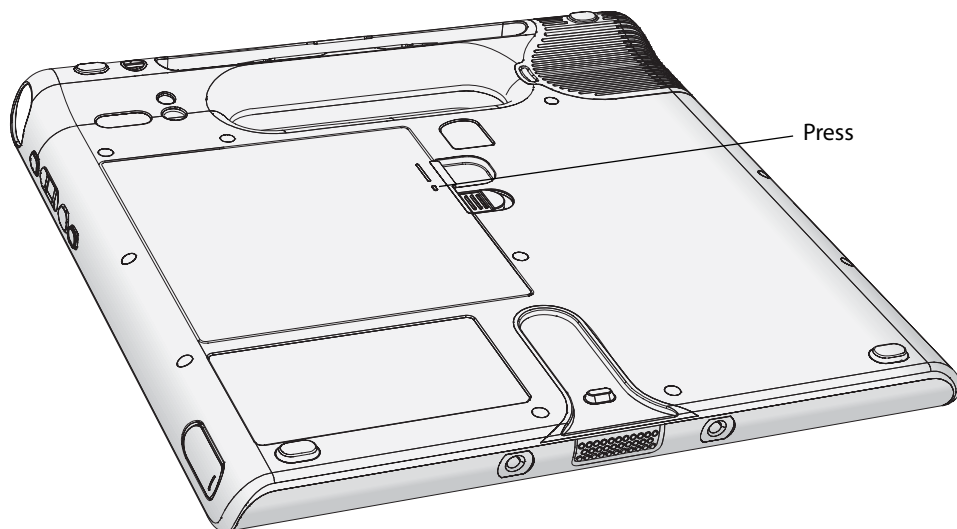

## Charging the battery

When the system is connected to AC power, the battery automatically charges until it reaches full charge, whether the unit is on or off.

For information about the battery status light on the front of the unit, see “Status lights” on page 10.



**DANGER:** To avoid injury, keep the battery within the recommended temperature range when charging it. If the battery has been subjected to extreme temperatures, wait until it cools to room temperature before recharging it. For more information, see the *Safety and Regulatory Guide* packaged with the system.

## Removing and replacing the battery

Before you remove the battery, ensure that the tablet is plugged in, turned off, or in Hibernate (page 40), Standby (page 39), or Sleep mode (Vista) (page 38).

### To remove the battery

1. With the back of the unit facing you, slide and hold the battery latch.
2. Insert your finger under the finger grip and remove the battery from the battery compartment.

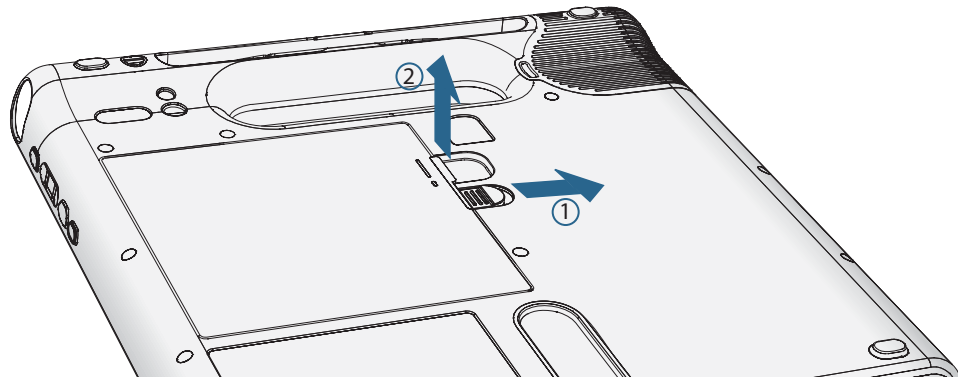

### To replace the battery

1. Place the tabbed end of the battery into the battery compartment.
2. Press the battery down until it locks in to place.

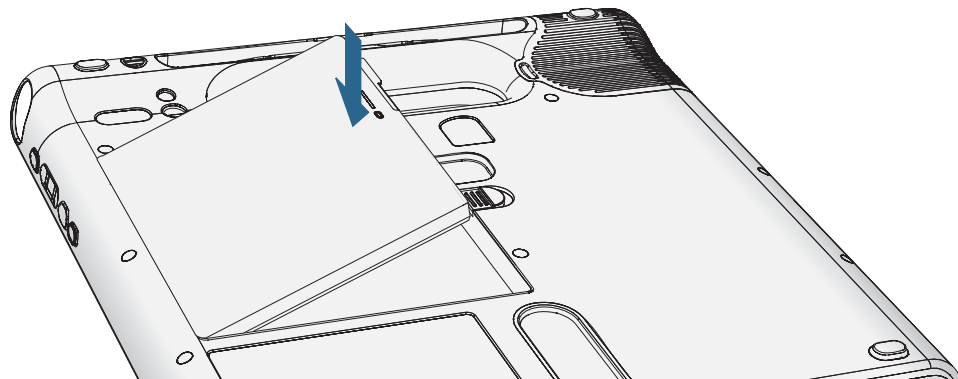

## Swapping the battery

You can swap the standard battery while the system is on, with or without having the system plugged in to AC power.

### To swap batteries

1. Put the tablet in Hibernate (page 40), Standby (page 39), or Sleep (Vista) (page 38) mode.
  - With Standby, the system will maintain your data for up to 30 seconds while you swap the battery. You may have less than 30 seconds if you have several applications running.
  - With Hibernate, you will have as long as you need to swap the battery.
2. Remove the battery (page 36).
3. Insert the new battery (page 36).

**Important:** Use only Motion Computing batteries with the system.

## Long-term battery storage (not attached to tablet)

Do not store any batteries with a full charge; this can cause a permanent loss of charging capacity. For long-term storage, ensure that the charge level is between 20% and 40% (two contiguous LEDs illuminated). You should check stored batteries every 90 days to determine the charge status. If only one LED or no LED is illuminated, recharge the batteries to a level between 20% and 40%.

For optimum care, store the battery in a cool, dry environment. Never expose the battery to temperatures above 60°C (140°F).

**Note:** In storage, the batteries will self-discharge at a rate of 10% of the total capacity per month.

## Battery and power management tips

- To lengthen the battery's usable life, use AC power when you can. The battery will charge automatically while you run on AC power, so leave the battery in the unit while you are working.
- Use AC power when using a CD or DVD drive.
- When running on battery power, place the system in Hibernate (page 40), Standby (page 39), or Sleep (page 38) mode if you are going to leave it unattended for more than a few minutes.
- Remember that the display, processor, wireless cards, and accessory drives all draw on the battery, so adjust properties and disable unused accessories while running on battery power. Open the Motion Dashboard to change the power and device settings.
- When running on battery power, adjust the display brightness to the dimmest setting you are comfortable with. See "Adjusting the display brightness" on page 25.

## Disposing of used batteries

A Lithium-ion (Li-ion) battery should be disposed of at a hazardous materials recycling center when it is no longer serviceable. Do not throw it in a waste receptacle because the battery could be deposited in a landfill.

## Using power management

Windows XP and Windows Vista include a comprehensive suite of power management functions that can help you maximize your tablet's performance or conserve power.

### To select a power plan

1. Open Motion Dashboard to the Power panel (page 20).
2. For Power plan or Power scheme, select the appropriate option.

For more information, see the Dashboard Help.

## Power management on Windows Vista

This section describes sleep and hibernate for tablets running Windows Vista. For information about creating and using power plans, see the Dashboard Help. For more information about power management settings, open Windows Help and Support and search for "power options".

## Using Sleep

Windows Vista offers a feature called Sleep that combines the benefits of Standby and Hibernate. When you put your tablet to sleep, your work is saved to the hard disk. When your tablet wakes, Windows restores your previous work session within seconds.

You can put your tablet to sleep manually from the Start button, or you can set it up to go to sleep when you press the power switch.

### To set up the power switch to put the computer to sleep

1. Open Motion Dashboard to the Power panel (page 20).
2. Select one or both of the following:
  - For Power switch on battery, select **Sleep**.
  - For Power switch plugged in, select **Sleep**.
3. To put the computer to sleep, press the power switch.

To resume your work, press the power switch again.

**Note:** This feature is available on Windows Vista only.

## Using Hibernate

Hibernation is a state in which the computer shuts down to save power but first saves everything in memory on the hard disk. When you restart the computer, your desktop is restored exactly as you left it. Use hibernation to save power when you will be away from the tablet for an extended time.

You can put your tablet on Hibernate manually from the Start button, or you can set it up to hibernate when you press the power switch.

### To set up the power switch to put the computer on Hibernate

1. Open Motion Dashboard to the Power panel (page 20).
2. Select one or both of the following:
  - For Power switch on battery, select **Hibernate**.
  - For Power switch plugged in, select **Hibernate**.
3. To put the computer on Hibernate, press the power switch.

To resume your work, press the power switch again.

## Power management on Windows XP

This section describes sleep and hibernate for tablets running Windows XP. For information about creating and using power plans, see the Dashboard Help. For more information about power management settings, search Windows Help and Support for “power options”.

## Using Standby

On tablets running Windows XP, you can use standby to save power when you will be away from the tablet for a short time.

Standby is a state in which the display and hard disks turn off, so that the tablet uses less power. When you want to use the tablet again, it comes out of standby quickly, although you may have to log on again. Because Standby does not save your data to the hard disk, a power failure while on Standby can cause you to lose unsaved information.

**Note:** This feature is available on Windows XP only.

### To set up the power switch to put the computer on Standby

1. Open Motion Dashboard to the Power panel (page 20).
2. For Power Switch will, select **Standby**.
3. To put the computer on Standby, press the power switch.

To resume your work, press the power switch again.

## Using Hibernate

Hibernation is a state in which the tablet shuts down to save power but first saves everything in memory on the hard disk. When you restart the tablet, your desktop is restored exactly as you left it. Use hibernation to save power when you will be away from the tablet for an extended time.

Hibernation has the following advantages over Standby:

- Hibernate saves the state of the desktop and applications.
- Hibernate consumes no battery power.
- When you return from the Hibernate state, you return to where you were when you entered hibernation.

### To put the computer on Hibernate

1. Open Motion Dashboard to the Power panel (page 20).
2. For Power Switch will, select **Hibernate**.
3. To put the computer on Hibernate, press the power switch.

To turn the computer back on, press the power switch.

## Using Wi-Fi (802.11a/b/g)

Use the information in this section to set up a Wi-Fi connection. Wireless access requires an 802.11a, 802.11b, or 802.11g access point. Internet access requires a working Internet connection.



**DANGER:** FAA regulations require that you disable any wireless connection when traveling by air. Failure to disable the wireless connection on the system while traveling by air can cause communications problems with aircraft instruments.

### Enabling or disabling Wi-Fi

Before you can establish a Wi-Fi connection, you must enable the Wi-Fi adapter. You can enable the Wi-Fi adapter using Motion Dashboard.

**Note:** Wireless cards consume battery power. To reduce power consumption when running on battery power and when Wi-Fi is not being used, disable Wi-Fi in the Motion Dashboard.

### To enable or disable Wi-Fi

1. Open the Motion Dashboard to the Wireless panel (page 20).
2. Select or clear the **Enable Internal 802.11 Wireless** check box.



## Setting up a Wi-Fi connection on Windows Vista

Use this procedure to create a Wi-Fi connection on Windows Vista.

### To set up a Wi-Fi connection

1. Open the Motion Dashboard to the Wireless panel (page 20).
2. Ensure that **Enable Internal 802.11 Wireless** is selected.
3. Tap the **Properties** button.
4. In the Network Connections window, double-tap on the wireless network you want to connect to.
5. In the *Connect to a network* window, tap on the network you want to connect to, and then tap **Connect**.

If you are connecting to a secure network, you may need to enter authentication information. If you are connecting to an unsecured network, you may be prompted to select whether to connect to the unsecured network or connect to a different network.

For more information about Wi-Fi, see “Wi-Fi (802.11a/b/g wireless)” on page 17.

## Setting up a Wi-Fi connection on Windows XP

Use this procedure to create a Wi-Fi connection on Windows XP.

### To set up a Wi-Fi connection

1. Open the Motion Dashboard to the Wireless panel (page 20).
2. Ensure that **Enable Internal 802.11 Wireless** is selected.
3. Tap the **Properties** button.
4. In the Network Connections window, double-tap on the wireless network you want to connect to.
5. In the Wireless Network Connection window, select the network you want to connect to and tap **Connect**.

If you are connecting to a secure network, you may need to enter authentication information. If you are connecting to an unsecured network, you may be prompted to select whether to connect to the unsecured network or connect to a different network.

For more information about Wi-Fi, see “Wi-Fi (802.11a/b/g wireless)” on page 17.

## Using Mobile Broadband

Use the information in this section to set up a Mobile Broadband connection. Mobile Broadband access requires a service contract from a Mobile Broadband service provider. For more information, see “Mobile Broadband” on page 18.



**WARNING:** FAA regulations require that you disable any wireless connection when traveling by air. Failure to disable the wireless connection on the tablet while traveling by air can cause communications problems with aircraft instruments.

### Activating your Mobile Broadband service

Before you can use the Mobile Broadband service, you must activate your account with the service provider you chose when you ordered your system. You may be able to activate your service using the connection manager software, or you may have to call your service provider. For more information about starting the connection manager, see the Mobile Broadband document included with the system.

### Enabling Mobile Broadband

Before you can establish a Mobile Broadband connection, you must enable the Mobile Broadband adapter. You can enable the Mobile Broadband adapter using Motion Dashboard.

**Note:** Wireless cards consume battery power. To reduce power consumption when running only on battery power and when Mobile Broadband is not being used, disable Mobile Broadband in the Motion Dashboard.

#### To enable Mobile Broadband

1. Open the Motion Dashboard to the Wireless panel (page 20).
2. Select the **Enable Mobile Broadband Internal Wireless** check box.

### Installing the connection manager

The connection manager software is preinstalled on your computer based on the service provider you chose when you ordered your system.

#### To install the connection manager

- Double-tap the connection manager installer icon on your desktop.

After the connection manager software installation is completed, the connection manager installer icon is replaced with the shortcut for the connection manager software.

For more information, see the connection manager Help.

**Note:** The connection manager software you use depends on your wireless service provider.

## Starting the connection manager

The connection manager software is preinstalled on your computer based on the service provider you chose when you ordered your system.

### To start the connection manager

- Double-tap the connection manager shortcut on your desktop.

For more information, see the connection manager help.

**Note:** The connection manager software you use depends on your wireless service provider.

## Connecting and disconnecting

Use the connection manager software to connect to your provider's Mobile Broadband network.

### To connect and disconnect

1. Start the connection manager (page 43).
2. Do one of the following:
  - To connect, click the appropriate button, such as **Connect** or **Go**.
  - To disconnect, click the appropriate button, such as **Disconnect** or **Stop**.

**Note:** The connection manager software you use depends on your wireless service provider.

## Using the SIM card slot

The SIM card slot holds one SIM (Subscriber Identity Module) card. A SIM card is a smart card, about the size of a postage stamp, that stores information about your wireless account.

You need to use a SIM card only if you are using Mobile Broadband on an HSDPA (High Speed Downlink Packet Access) network

. Contact your service provider for details.

### To insert a SIM card

1. Turn off the system and remove the battery (page 36).

2. Locate the SIM slot door and open it.

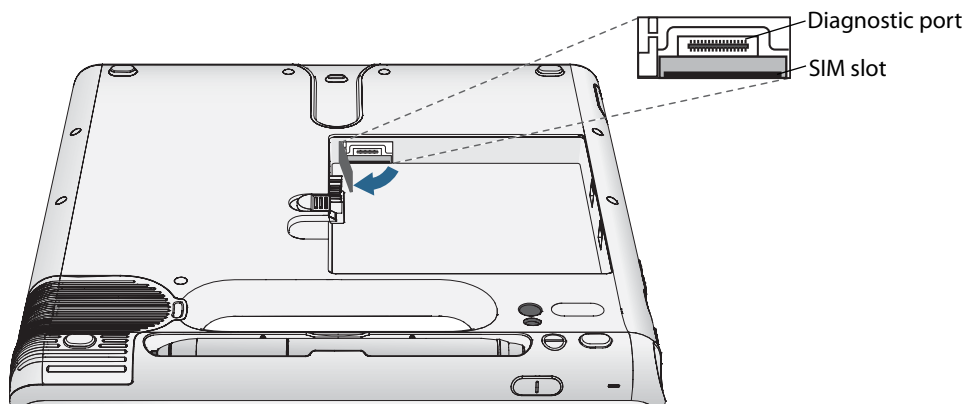

**Note:** The SIM slot and a diagnostic port are behind the SIM slot door. The SIM slot is below the diagnostic port.

3. Place the SIM card label side down on the battery tray. Ensure that the notch on the SIM card is in the upper right corner.

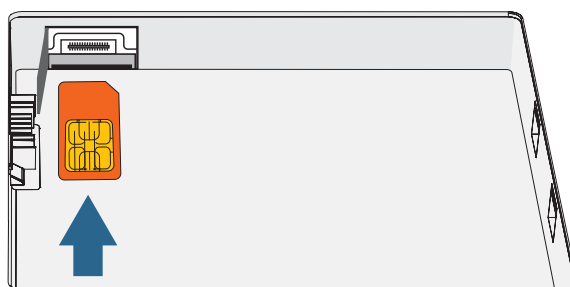

4. Slide the SIM card into the SIM card slot until it clicks into place. You may need to use a paper clip to push the SIM card all the way in.

#### **To remove a SIM card**

1. Turn off the system and remove the battery (page 36).
2. Open the SIM slot door.
3. Press the card in slightly until it pops out. You may need to use a paper clip to push the SIM card in to release it.

# Using Bluetooth

You can use Bluetooth® to connect to accessory devices or other computers. The devices can communicate with each other when they are in range. For more information, see “Bluetooth wireless” on page 18.

## Enabling or disabling Bluetooth

Before you can set up a Bluetooth device, you must enable the Bluetooth adapter on the tablet. After you enable Bluetooth, the Bluetooth icon () appears in the notification area. You can tap on this icon to get shortcuts to the Bluetooth Settings window, the Bluetooth File Transfer Wizard, and the Add New Connection Wizard.

**Note:** Wireless cards consume battery power. To reduce power consumption when running on battery power and when Bluetooth is not being used, disable Bluetooth in the Motion Dashboard.

### To enable or disable Bluetooth

1. Open Motion Dashboard to the Wireless panel (page 20).
2. Select or clear **Enable Internal Bluetooth Wireless**.

After you enable Bluetooth, the Bluetooth adapter tries to discover other Bluetooth devices within range. When a Bluetooth device is discoverable, it is visible to other Bluetooth devices in range. For information about making a device discoverable, see the device’s documentation.

## Setting up a Bluetooth device on Windows Vista

Before you can use a Bluetooth device with the system, you need to set up the device. After the device is paired with the system, a passkey is used to create a secure connection between the system and the Bluetooth device.

**Note:** Although the passkey exchange helps to secure your data, Bluetooth wireless technology should not be considered completely secure.

### To set up a Bluetooth connection

1. Place the Bluetooth device in discoverable mode. Each Bluetooth device may have a different way to make it discoverable. See the manufacturer’s documentation for more information.
2. Open Motion Dashboard to the Wireless panel (page 20).
3. Select **Enable Internal Bluetooth Wireless**.
4. Tap the **Properties** button.
5. In the Devices tab, select the device you want to connect to, and then tap **Add**.
6. Follow the instructions in the setup program. If you have trouble setting up the device, see “If the device is not discovered...” on page 47.

The Bluetooth device is ready to use. Paired devices are shown in the Bluetooth Settings window. The following illustration shows a Bluetooth Settings window with two Bluetooth devices.

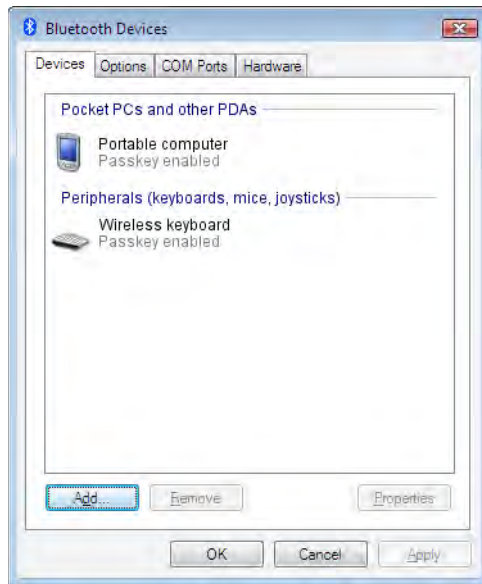

## Setting up a Bluetooth device on Windows XP

Before you can use a Bluetooth device with the system, you need to set up the device. After the device is paired with the system, a passkey is used to create a secure connection between the system and the Bluetooth device.

**Note:** Although the passkey exchange helps to secure your data, Bluetooth wireless technology should not be considered completely secure.

### To set up a Bluetooth connection

1. Place the Bluetooth device in discoverable mode. Each Bluetooth device may have a different way to make it discoverable. See the manufacturer's documentation for more information.
2. Open Motion Dashboard to the Wireless panel (page 20).
3. Select **Enable Internal Bluetooth Wireless**.
4. Tap the **Properties** button.
5. In the Add New Connection window, select **Express** and tap **Next**.
6. Under Bluetooth devices, select the device you want to connect to and tap **Next**. If you have trouble setting up the device, see "If the device is not discovered..." on page 47.
7. If required, enter the number shown in the Passkey field and press **Enter**. See the manufacturer's documentation for more information.
8. Enter a name for the device and tap **Next**. After the Bluetooth installation finishes, tap **Finish**.

The Bluetooth device is ready to use. Paired devices are shown in the Bluetooth Settings window. The following illustration shows a Bluetooth Settings window with a Bluetooth keyboard and mouse.



#### **If the device is not discovered...**

If the Bluetooth device is not detected after multiple attempts, try the following:

- Ensure that Bluetooth is enabled (page 45).
- Ensure that the device you are adding is discoverable. See the manufacturer's documentation for more information.
- Ensure that the Bluetooth device has good batteries.
- For keyboards, mice, and printers, ensure that you select **My device is set up and ready to be found** in the Add Bluetooth Device Wizard.
- For two computers transferring files, both computers must turn on the device transfer wizard, although only the receiving computer needs to be discoverable. Tap the Bluetooth icon and then **Send a file** or **Receive a file**. When you do this, discovery is automatically turned on for the receiving computer.
- Check which Bluetooth devices are connected. In the notification area, tap the Bluetooth icon and select **Open Bluetooth Settings**. In the Devices window, you will see the Bluetooth devices that are currently connected.

If the system still cannot detect the Bluetooth device, contact the device manufacturer for more information.

**Bluetooth wireless tips**

Motion Computing and its Bluetooth partners have worked to ensure a positive experience with this technology, and to ensure Bluetooth interoperability. In doing so, we have found the following issues:

- If you are running Bluetooth and Wi-Fi at the same time, interference can affect the Bluetooth performance. This is most noticeable when you try to transfer large amounts of data, such as transferring files or printing large documents.
- Some Bluetooth devices will disconnect when they go into power-saving mode. Most devices will automatically reconnect when they become active again.
- Occasionally, some Bluetooth device compatibility issues can occur. If you have problems with interoperability of Bluetooth devices, contact the manufacturer of the device and check its compatibility with the Bluetooth software on the system.
- The tablet comes with Bluetooth software from Toshiba (on XP) or Microsoft (on Vista), although you can use other Bluetooth software. For more information, go to the Motion Computing Knowledge Base at [www.motioncomputing.com/kb](http://www.motioncomputing.com/kb) and search for "Bluetooth".



# Using Motion OmniPass and the fingerprint reader

Motion OmniPass offers a secure and convenient system for managing your passwords and providing confidentiality for your sensitive data.

## To start Motion OmniPass

- In the notification area, double-tap the Motion OmniPass icon (🔑).

Also, you can start Motion OmniPass from the Security panel of Motion Dashboard.

The following illustration shows the Motion OmniPass Control Center.



From the OmniPass Control Center, you can manage OmniPass users and settings (distinct from Windows users), change OmniPass settings, manage passwords, and protect your files. For more information, see the OmniPass Help.

## Capturing a fingerprint

After you capture your fingerprints, you can associate the fingerprints with an OmniPass user. This offers a quick and convenient way to log on to the system, provides global password management, and helps protect your data from unauthorized access.

Use this procedure to enroll a new user and capture a fingerprint for authentication.

### To capture a fingerprint

1. Start Motion OmniPass (page 49) and tap **Run Enrollment Wizard**.
2. Enter the Windows account information for the new user and tap **Next**. The fields may default to the user name of the current user.
3. If you are prompted to select an authentication device, select **Fingerprint Device**.

4. In the Choose Finger window, tap on the finger you want to enroll, then tap **Next** or **Practice**. Practice allows you to do a trial run of the fingerprint capture.

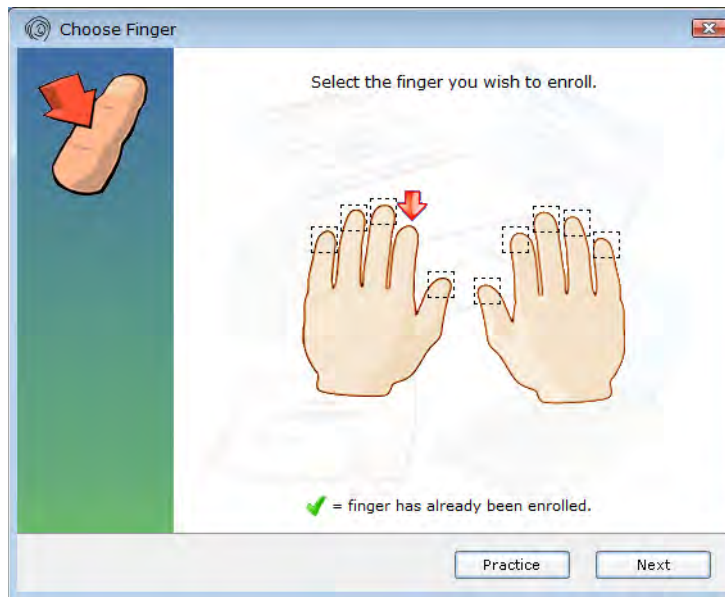

5. Place the selected finger over the fingerprint reader and slowly drag your finger across the sensor from right to left or left to right.

If the capture is successful, a green fingerprint image will appear in the capture area. If the capture is unsuccessful (red fingerprint image), follow the instructions on the screen to improve the scan.

After you have successfully captured your fingerprint, scan your fingerprint one more time for verification.

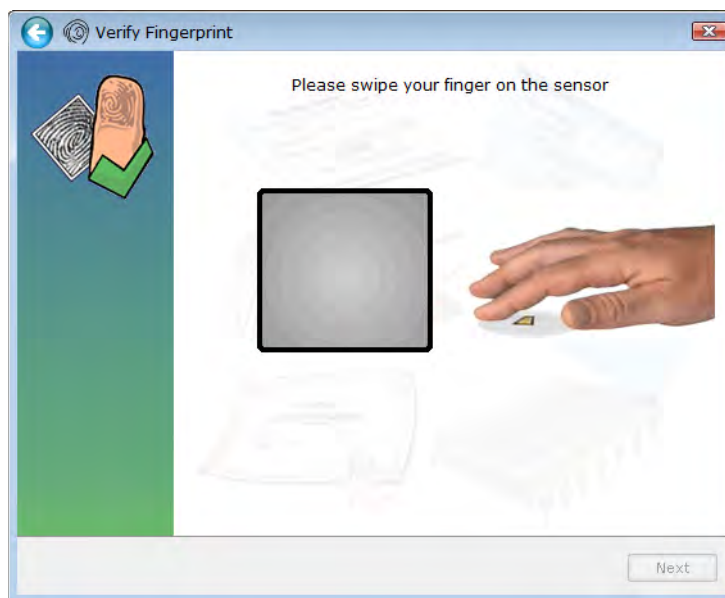

6. Tap **Next**, then tap **Yes** if you want to enroll a second fingerprint (recommended). If you injure a finger, you can use a second finger to authenticate.

You can also capture a second fingerprint later. From the OmniPass Control Center, tap **Run Enrollment Wizard**, then tap **Modify a user's device enrollment**.

7. Select **I am done with enrolling security authentication devices** and tap **Next**.
8. Select your user preferences and tap **Next**. On the Backup User Profile screen, tap **Next**.
9. Select a location for your backup profile and tap **Save**. Enter a password and tap **OK**. On the final screen, tap **Done**.

You should keep your backup profile in a secure location, such as on an external drive that you can remove and store in a secure environment.

If your profile is lost or corrupted, you can restore it later. You should back up your profile periodically to protect your configuration and any stored passwords and encryption keys. For more information, see the OmniPass Help.

#### **Fingerprint reader tips**

- Be consistent. Hold your finger and scan at the same angle each time. For example, if you enroll your finger with your hand open, hold your hand this way each time you scan.
- The scanner is bi-directional. You can move your finger from right to left or left to right.
- Read the prompts carefully and ensure that you wait for the prompt before you swipe.
- Swiping too fast or too slow can make a capture unsuccessful. Change the swipe speed until you learn what speed works best.
- When scanning, press hard enough to fully contact both the nickel-colored ring and the sensor; you do not have to press hard.
- Rub your fingers together to stimulate the natural skin oils so your fingerprint is easier to detect. Conversely, wipe your finger off so nothing interferes with the scan.
- If you are having trouble enrolling a specific finger, enroll a different finger. Typically, you should scan an index finger, thumb, middle finger, ring finger, and little finger in that order.
- If you are repeatedly having trouble getting a good scan, you may need to clean the sensor. See "Cleaning the fingerprint reader" on page 61.

## Using password replacement

OmniPass can manage your passwords for other applications, such as Web sites, Internet email, FTP, or any restricted-access network resource. After OmniPass registers your credentials, you can access any of these restricted areas by using your fingerprint or the master password.

### To register passwords

1. When you encounter a user name and password prompt, enter your user name and password, but do not log on. (Do not tap **Enter**, **Submit**, or **OK**.)
2. Right-click the OmniPass icon, and select **Remember Password**. The Windows arrow pointer changes to the OmniPass golden key.
3. Click the key cursor on the window that has the password that you want OmniPass to remember.

**Note:** For some applications, you may have to use the password wizard to register passwords. See "Using the password wizard" on page 52.

4. Enter the following information:
  - **Friendly Name.** A descriptive name to identify the password box.
  - **Automatically enter.** Instantly accesses the site without requiring a password or fingerprint scan. If you are logged in to OmniPass and you access a secure Web site, OmniPass will automatically submit your user name and password without prompting for verification.
  - **Automatically click.** Prompts you for your OmniPass/Windows password or fingerprint scan when you access the site (default).
5. Tap **Finish**.
6. If prompted, swipe your fingerprint or enter your master password to authenticate these settings.

## Using the password wizard

Certain applications require more sophisticated user input for authentication. For these applications, you may need to use the password wizard to set up password replacement.

### To run the password wizard

1. Start Motion OmniPass (page 49).
2. In the left pane, tap **Password Wizard**.
3. Follow the instructions in the wizard program.

## Logging on to a remembered site

To log on to a remembered site, open the Web site or application that you have set up with password replacement. See “Using password replacement” on page 52. Swipe your finger or enter the master password when prompted.

To remove a remembered site, tap **Manage Passwords**.

## Setting up strong logon security

For an additional level of security, you can enable strong logon security. Strong logon security forces you to authenticate with a specific security device (such as the fingerprint reader or a Smart Card) before allowing access to Windows.

### Notes:

- After strong logon security is enabled, the Windows Welcome screen and Windows Fast User Switching are disabled.
- After strong logon security is enabled, if the fingerprint reader or smart card reader fails, you may not be able to log on to the computer.

### To enable strong logon security

1. Start Motion OmniPass (page 49).
2. Tap **Change Your OmniPass Settings**.
3. Tap the **Change System Settings** tab.
4. Select the **Enable strong logon security** check box.
5. Tap **Save all changes**.
6. Tap **OK** and restart the computer.

After you restart the computer, you should configure the authentication rules for strong logon security.

### To configure authentication rules

1. Start Motion OmniPass (page 49).
2. Tap **Change Your OmniPass Settings**.
3. Tap **Set user authentication rules and policies**.
4. Select the appropriate authentication rules.
5. Tap **OK**.

# Using Windows Security Center

Windows Security Center provides a central location for you to manage the tablet's security settings and learn more about improving security. If a problem is detected (such as an out-of-date antivirus application), the Security Center sends you an alert and provides recommendations for how to remedy the situation.



**Note:** Windows Security Center differs slightly between Windows Vista and Windows XP.

To learn more, open Motion Dashboard to the Security panel, then tap **Windows Security Center**.

## Setting up users and passwords

You can use different types of user accounts and passwords to create various levels of protection for computer and its data, depending on the level of security that you need.

### Setting up Windows user accounts

You can use Windows user accounts to help secure the files on the tablet from other users. You must have an administrator account on the tablet to add a new user to the tablet.

#### To set up a Windows user account

1. In Control Panel, open User Accounts.
2. Do one of the following:
  - For Windows Vista, tap **Manage another account**, then tap **Create a new account**.
  - For Windows XP, tap **Create a new account**.
3. Enter the appropriate information for the new user account.

## Setting a BIOS password

You can use a BIOS password to secure the basic input/output system of the tablet.



**WARNING:** Read this section carefully to understand the implications of creating a BIOS system password. If you forget the password, you will not be able to access the BIOS. If this happens, contact Motion Computing Technical Support at [www.motioncomputing.com/support](http://www.motioncomputing.com/support). Have the serial number ready. You can find the serial number in System Properties. To open System Properties, tap **Start** and then tap **Control Panel**. Double-tap **System**.

### To set a BIOS password

1. Start the system. When the Motion Computing splash screen appears, tap the screen with the pen. On the TrustedCore menu, tap **Password Options**. If you miss the splash screen, restart the computer and try again.
2. In the Password Options window, enter a password using the on-screen keyboard. Enter the password again to confirm it.
3. Do one of the following:
  - If you want to require a password every time the computer starts, select the **Enable password on boot** option.
  - If you want to require a password only to start the BIOS, clear the **Enable password on boot** option.
4. Tap **OK**.

To clear the password, leave the password fields blank, then tap **OK**.

## Setting up a hard disk drive password

You can use a hard disk drive password to protect the tablet and the hard disk drive. The tablet cannot be started without the HDD password, and the data on the disk drive cannot be accessed, even if it is removed and attached to a different computer.

### To set up an HDD password

1. Start the system (page 5).
2. When the Motion Computing splash screen appears, tap the screen with the pen. On the TrustedCore menu, tap **Launch System Setup**. If you miss the splash screen, restart the tablet and try again.
3. In the PhoenixBIOS Set Up Utility, tap **Security** on the menu bar.
4. Double-tap **Enter** for **Set Hard Disk Password**.
5. Enter a password using the on-screen keyboard and tap **Enter**. Enter the password again to confirm it and tap **Enter**.
6. Tap **Exit**, then select **Exit Saving Changes**.

To clear the password, double-tap **Enter** for **Set Hard Disk Password**. Enter the current password, then tap Enter twice to leave the **Enter New Password** fields blank.

## Finding additional software

For information about other software for the your tablet PC, go to the Motion Computing software page at [www.motioncomputing.com/products/software\\_motion.asp](http://www.motioncomputing.com/products/software_motion.asp).

You will find links to software solutions for purchase as well as free downloads from Motion software and service partners.



# Care and Maintenance

# 4

Proper care and maintenance will keep your tablet PC working and in good condition for a long time. This chapter describes the care and maintenance procedures for the system. For general information about care of the tablet PC and its components and accessories, see the *Safety and Regulatory Guide* packaged with the system.



**WARNING:** Follow the guidelines listed below when maintaining the tablet PC and its components. Improper use may damage the unit and its components and void the warranty.

## General care

- Protect the system from exposure to extreme temperatures, shock, liquids, and strong magnetic fields.
- If you are storing the system for a long time, unplug the power adapter and remove the battery after partially discharging it.
- Do not place heavy objects on top of the unit.
- Do not open the case. Opening the case will void your warranty.

## Standard display

- Clean fingerprints and most marks from the display surface by wiping it with the soft cloth (provided). Do not pour liquids directly onto the display surface itself. Do not use an abrasive cleaner on the display. If liquid is spilled on the display, wipe it up immediately. For more information, see “Cleaning in a health care environment” on page 59.
- Avoid using tissues or paper towels to clean the display surface. These contain wood fibers that can scratch the display.
- Use only a Motion Computing pen on the display. Do not write on the display with an ink pen or pencil, or any other object that could damage the display surface.
- Protect the display surface from unnecessary contact by using a case when transporting the unit.
- Avoid exposing the display to direct sunlight for long periods of time.

## View Anywhere display

- Clean fingerprints and most marks from the display surface by wiping it with the soft cloth (provided). Do not spray or pour liquids directly onto the display surface itself. Do not use an abrasive cleaner on the display. If liquid is spilled on the display, wipe it up immediately. For more information, see “Cleaning in a health care environment” on page 59.
- If needed, clean with any alcohol-based product recommended for anti-reflective glass. Other cleaning products might leave a residue.
- Avoid using tissues or paper towels to clean the display surface. These contain wood fibers that can scratch the display.
- Use only a Motion Computing pen on the display. Do not write on the display with an ink pen or pencil, or any other object that could damage the display.
- Protect the display surface from unnecessary contact by using a case when transporting the unit.
- Avoid exposing the display to direct sunlight for long periods of time.

# Cleaning in a health care environment

This section describes the cleaning procedures for the tablet PC in a health care environment.

## Disinfecting procedures

You should periodically disinfect the system according to the institutional policies of surface and equipment safety and cleanliness. Motion has tested a variety of antimicrobial solvents and information on specific products is available upon request.

According to the Centers for Disease Control and Prevention, “items that do not ordinarily touch the patient or touch only intact skin are not involved in disease transmission, and generally do not necessitate disinfection between uses on different patients”.<sup>1</sup> We recommend using an EPA-approved low-level disinfectant when general cleaning is required. For a list of cleaning solutions tested by Motion Computing, see “Cleaning solutions” on page 60.

If the system becomes soiled with blood or other body fluids, a hospital-approved low-level disinfectant that is tuberculocidal/virucidal when used at recommended dilutions and contact times can be used.

Visibly soiled areas should first be cleaned and then disinfected, or a detergent disinfectant can be used. For disinfection, the cleaned areas should be moistened with the appropriate germicide and allowed to air dry.<sup>2</sup>

If the system is used with patients who are infected or colonized with vancomycin-resistant enterococci or other drug-resistant microorganisms judged by the infection control program (based on current state, regional, or national recommendations, to be of special or clinical or epidemiologic significance or with highly virulent microorganisms such as Ebola or Lassa), then the unit should be dedicated to one patient or patient cohort or subjected to low-level cleaning between patient uses.<sup>1</sup>

---

1. Centers for Disease Control and Prevention. “Sterilization or Disinfection of Medical Devices-General Principles.” 2002.

[www.cdc.gov/ncidod/dhqp/bp\\_sterilization\\_medDevices.html](http://www.cdc.gov/ncidod/dhqp/bp_sterilization_medDevices.html) (20 Sept. 2006).

2. Centers for Disease Control and Prevention. “Sterilization or Disinfection of Patient-Care Equipment-HIV Related.” 2000.

[www.cdc.gov/ncidod/dhqp/bp\\_sterilization\\_patient\\_care.html](http://www.cdc.gov/ncidod/dhqp/bp_sterilization_patient_care.html) (20 Sept. 2006).

## Training and documentation considerations

All users of tablet computers in the health care environment should be provided with training on proper cleaning procedures. Cleaning procedures should be added to the institution's policies and procedures for infection prevention.

## Cleaning solutions

This section describes various cleaning solutions that have been tested by Motion Computing. Review the manufacturer's guidelines for proper use of the product.

Product Type	Manufacturer	Comments
Vira-Guard	Veridien	Concentrated Isopropanol. Does not leave film.
Cavi-Wipes	Metrex	Isopropanol and Ethylene Glycol Monobutyl Ether. Leaves a slight film which needs a secondary wipe with dry cloth to remove.
Sani-Cloth	PDI	Quaternary Ammonium. Leaves a slight film which needs a secondary wipe with dry cloth to remove.

## Cleaning the fan cover

If the fan cover becomes soiled, it can be removed and cleaned.

### To clean the fan cover

1. Shut down the system, unplug it, and remove the battery.
2. Turn the unit over so that the back side is facing up.
3. Press the fan cover release button.

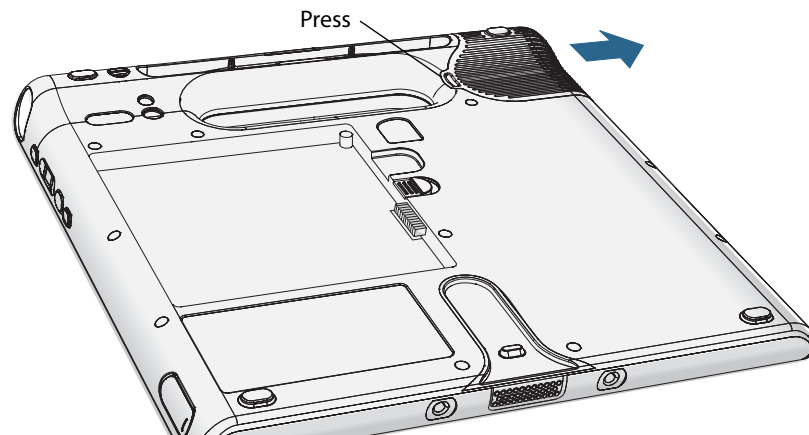

4. Slide the fan cover away from the unit to remove it.
5. Clean the fan cover according to the guidelines for your organization.
6. After the fan cover is clean and dry, slide it back onto the unit until it snaps into place.

## Cleaning the fingerprint reader

Under normal circumstances, you should clean the fingerprint reader once a month, or whenever necessary.

### To clean the fingerprint reader

1. Shut down the system, unplug it, and remove the battery.
2. Lightly spray a cotton swab with household window cleaner.
3. Gently rub the sensor surface with the cotton swab, slowly rotating the swab so a new, clean surface of the swab is constantly exposed to the sensor surface. Do not allow cleaner to drip or run down into the electronics around the sensor.

Do not use bleach, solvents, or abrasives. Do not spray or pour any liquid directly on the sensor.

4. After cleaning, gently rub the surfaces again with a clean, dry cotton swab. Use a clean swab each time you clean the sensor.

## Pen

- Store the pen in the pen holder or in a case when not in use.
- Do not store the pen vertically on the tip. Constant pressure on the tip can affect the pen-to-digitizer interaction.
- Change the pen tip regularly. See “Replacing pen tips” on page 62.
- Do not immerse the pen in liquid. It contains electronic components that could be damaged.
- In certain environments, particles or debris can stick to the pen tip or the display. To avoid damaging the display, clean it frequently with the provided cleaning cloth. Also, change pen tips regularly, especially if you drop the pen onto a rough surface that could damage the tip or embed debris in it. Damaged pen tips can scratch the display.

## Replacing pen tips

Pen tips eventually wear down or get damaged, so the pen includes extra tips and a tool for replacing them.

With typical use, you should change the pen tip every 90 days. If you use the pen in a dirty environment, you should change the pen tip every 30 days. Particles can become embedded in the pen tip and scratch the display.

### To replace the pen tip

1. Grasp the old tip with the replacement tool. Use the notch on the ring to grab the tip.
2. Pull the old tip out of the pen.
3. Insert a new tip.
4. Apply slight pressure to push the tip in to place.

## Ordering new pens

To order additional pens, go to the Motion Computing accessories page at [www.motioncomputing.com/accessories](http://www.motioncomputing.com/accessories).

## Traveling with the system

Use the following tips when you travel with the system.

- Remove all accessories and cables. Remember to pack those you will need while traveling, including at least one pen.
- Put the unit into a case to protect the display.
- Protect the pen by keeping it in the pen holder or in a case during travel.
- Pack the unit securely in a briefcase or hand-carried luggage, and keep it separate from toiletries, liquids, and food. Do not pack it in checked luggage.
- Keep the system stable during travel. Secure it to prevent it from sliding around in overhead bins and car trunks.
- Before extended use in the field or long trips away from AC power, adjust the power properties to maximize battery conservation. You can adjust the power properties from Motion Dashboard. See “Using power management” on page 38.
- For international travel, obtain and use the appropriate adapters for your destination’s electrical outlets. A current converter is not necessary.
- You may want to carry proof of ownership or a merchandise passport when traveling internationally.
- Consult your insurance company and credit card company to learn about emergency travel assistance in case the system becomes lost or disabled.

## Traveling by air

Use the following tips when traveling by air.

- Have a fully charged battery in case security personnel ask you to start the system.
- Have it hand-inspected or sent through the X-ray scanner, but never carry it through the metal detector.
- Turn off the system or place it in hibernation mode for takeoff and landing.

## FAA Wireless air travel requirement

The FAA requires that you suspend wireless operations, such as Wi-Fi and Bluetooth, before boarding a plane.



**DANGER:** Do not transport Li-ion batteries in checked baggage. The baggage hold can get very hot, which can overheat the Li-ion battery and result in an explosion. You can take up to two spare batteries in carry-on luggage, in addition to the one in the unit. Transporting batteries in checked baggage or transporting more than two spare batteries is a violation of federal transportation regulations.

## Restoring data

You can use the Acronis True Image software to restore your tablet to the state it was in when it left the factory. Additionally, you can create your own backup data archives and restore those later. For more information, see the Acronis True Image Help.

## Using Acronis True Image in Windows

You can use Acronis True Image in Windows or from the boot menu. We recommend that you run Acronis True Image in Windows to access the full feature set.

### To restore using Acronis True Image in Windows

1. Start Acronis True Image by double-tapping the **True Image** icon on the Windows desktop.
2. Tap **Recovery**.
3. Follow the instructions in the Restore Data Wizard. For more information, see the Acronis True Image Help.

## Using Acronis Startup Recovery Manager

If you cannot start Windows, you can run Startup Recovery Manager when you start the tablet. If the operating system will not start, you can use Startup Recovery Manager to restore damaged partitions.

### To restore from the Startup Recovery Manager

1. Start the system (page 5).
2. When the Acronis screen appears, press the Enter button (page 11) or the Enter key on the keyboard (optional).
3. Tap **Start Acronis True Image**.
4. Tap **Recovery**.
5. Follow the instructions in the Restore Data Wizard. For more information, see the Acronis True Image Help.

## Creating a backup archive

If you want to roll back your system to a predetermined state, you can create a backup archive.

### To create a backup archive

1. Start Acronis True Image by double-tapping the **True Image** icon on the Windows desktop.
2. Tap **Backup**.
3. Follow the instructions in the Create Backup Archive Wizard. For more information, see the Acronis True Image Help.

## Creating a bootable disk

You can create a bootable recovery disk that you can use if you are ever unable to start your tablet.

**Note:** For this procedure, you need a Docking Station and an external CD+/-RW drive, DVD+/-RW drive, or USB flash drive (16 MB or larger).

### To create a bootable disk

1. Start Acronis True Image by double-tapping the **True Image** icon on the Windows desktop.
2. Tap **Create Bootable Rescue Media**.



3. Follow the instructions in the Bootable Rescue Media Builder. For more information, see the Acronis True Image Help.

## Removing the Acronis OEM Zone

The Acronis OEM Zone is a special partition on the tablet's hard disk drive that stores the original factory backup archive. If you have created your own hard disk drive backup archive and a bootable disk, you can delete the OEM zone to free up some disk space.



**WARNING:** Removing the Acronis OEM Zone will disable Acronis Startup Recovery Manager and the original factory backup archive. Do not remove the Acronis OEM Zone unless you have created your own bootable media and a backup archive.

### To remove the OEM Zone

1. Start Acronis True Image by double-tapping the **True Image** icon on the Windows desktop.
2. Tap **Remove Acronis OEM Zone**.
3. Follow the instructions in the wizard. For more information, see the Acronis True Image Help.



# Troubleshooting and Support

# A

Motion Computing products are thoroughly tested for performance and quality, but occasionally problems still occur. If you do not find the information you are looking for in this section, go to the Motion Computing support page at [www.motioncomputing.com/support](http://www.motioncomputing.com/support).

## Troubleshooting

Use the information in this section to identify and resolve common issues. If an issue has more than one potential cause, the most common cause is listed first.

### Power

#### **The tablet does not turn on**

- The unit might not be plugged in or the battery might be depleted. Plug the unit in to AC power.

#### **The tablet does not shut down**

- An application might have stopped responding. Use Task Manager to manually stop the application. For more information, open Windows Help and Support and search for “task manager”.
- The operating system may have stopped responding. Hold the power switch for five seconds to force the tablet to shut down.

#### **The tablet will not enter Hibernation mode.**

- Hibernation might not be enabled. Use Motion Dashboard to enable Hibernation. See “Using Hibernate” on page 40.

#### **The tablet does not return from Hibernation while on battery power**

- The battery might be depleted. Plug the unit in to AC power.

### **The display goes black while the system is still turned on**

- The computer might have turned off the display to save power. To restore the display, touch the screen with the pen or press a button.
- The tablet might have gone into Standby mode. Press and hold the power switch for about one second.
- The tablet might have gone into low-battery Hibernation mode. Plug the tablet in to AC power, then press and hold the power switch for about one second.

## Battery

### **The battery does not last very long (less than three hours)**

- Hot or cold conditions can adversely affect the battery charge. Use AC power if you are operating the tablet in these conditions.
- Accessory devices, such as a DVD player, and applications that make heavy use of the hard drive can drain the battery more quickly.
- The battery may be weakening. Use a different battery if possible.

### **I lost data while swapping batteries**

- The computer will maintain data and settings for 30 seconds in Standby mode. This time may vary due to the programs that are running. Try putting the tablet into Hibernate mode before you swap batteries. See "Using Hibernate" on page 40.

## Display

### **The display is too dim**

- The brightness may be set too low. Use Motion Dashboard to increase the brightness. See "Adjusting the display brightness" on page 25.

### **The desktop area is larger than the display**

- The display resolution may be set higher than the native resolution of the LCD display. In this case, the desktop area scrolls as you move around. Use Windows Display Properties to decrease the display resolution to 1024 × 768 pixels. For more information, open Windows Help and Support and search for "change resolution".

### **The display is unreadable or distorted**

- The display resolution might not match the native resolution of the LCD display. You can use other display resolutions, but you will get the best display quality when the display resolution matches the native resolution of the LCD display. Use Windows Display Properties to set the display resolution to 1024 × 768 pixels. For more information, open Windows Help and Support and search for "change resolution".

- The display driver may have been removed or become corrupted. Use Windows Device Manager to reinstall the driver. For more information, open Windows Help and Support and search for “update driver”.

## Input

### **The system does not respond to the pen I am using**

- You may be using an improper input device. Only Motion Computing digitizer pens can be used. The system does not respond to other pens or to a plastic stylus.
- You may be using the wrong pen. Occasionally, a particular pen may not work with a particular unit. If you are in an environment with multiple units and pens, try using a different pen. You can also tether the pen to the unit to ensure that a pen stays with it.

### **The pointer on the screen does not align with the pen**

- The pen may need to be calibrated. See “Calibrate the digitizer” on page 6.

### **When I write, I inadvertently click the function button on the pen**

- Adjust how you hold the pen. Avoid resting your finger on the function button. You can also use the Pen and Input Devices window to disable the button. See “Configuring pen options” on page 22.

### **The function button does not work**

- The function button may not be enabled. You can use Tablet and Pen Settings window to enable the function button. See “Configuring pen options” on page 22.
- You may not be pressing the button early enough. Try pressing the function button before you touch the pen to the display surface.

### **The eraser does not work**

- The eraser may not be enabled. You can use Tablet and Pen Settings window to enable the eraser. See “Configuring pen options” on page 22. The eraser works on digital ink only, not text.

### **The buttons on the unit do not do what I expect them to do**

- The button functions may have been customized. You can use the Tablet and Pen Settings window to change the buttons to the desired functions. See “Configuring front panel buttons” on page 24.

## Ports and connectors

### **The unit is in the docking station, but the system does not recognize any accessory devices, such as the external disk drive or monitor**

- The unit may not be fully seated in the docking station. Remove the unit from the docking station and then replace it.

## Network

### **The wireless adapter keeps connecting even when I do not want it to**

- The wireless adapter is enabled. You can use Motion Dashboard to disable the wireless adapter. See “Enabling or disabling Wi-Fi” on page 40.

## Audio

### **No sound is coming from the speakers**

- The volume may be set too low or muted. You can use Motion Dashboard to increase the volume or turn mute off.
- The integrated audio components may have been overwritten. If you install a third-party audio device (such as a USB or Bluetooth device), the integrated audio may stop working. If this occurs, reinstall the SigmaTel and Knowles IntelliSonic audio drivers. You can find the drivers at [www.motioncomputing.com/support/driver\\_download.asp](http://www.motioncomputing.com/support/driver_download.asp). If you still have problems after reinstalling the drivers, contact Motion Technical Support.

## System

### **I forgot my BIOS password and cannot access my computer**

- You can enter several incorrect passwords before the BIOS temporarily locks the system. You can try again by restarting the system. If you still cannot log on, contact Motion Computing Technical Support at [www.motioncomputing.com/support](http://www.motioncomputing.com/support).

### **An application has stopped responding, but I can still move the pointer and use other applications**

- Use Task Manager to manually stop the application. For more information, open Windows Help and Support and search for “task manager”.

### **The computer seems to be operating more slowly than usual**

- The hard disk drive may be full or nearly full. You can use Disk Cleanup to free up space on the hard drive. For more information, open Windows Help and Support and search for “disk cleanup”.
- The hard disk may need to be defragmented. You can use Disk Defragmenter to consolidate files and folders on the hard drive. For more information, open Windows Help and Support and search for “defragment”.

## Frequently asked questions

### **How can I make the battery charge last longer?**

- Use a power saver power plan. For more information, see “Using power management” on page 38.
- Set the display brightness to the dimmest level you are comfortable with. See “Adjusting the display brightness” on page 25.
- Disable the wireless adapter and Bluetooth adapter if you are not using them.
- Stop unnecessary background applications and processes.

### **What do I need to use the system in another country?**

- You will need a travel plug adapter. You can find these in airports and travel stores. You do not need to buy a voltage converter; the Motion AC adapter will automatically adjust to different voltages.

### **How do I clean the standard display screen?**

- To clean the acrylic display screen, wipe it with a soft cloth (like the one supplied) onto which you have sprayed a window-type cleaner. Do not spray cleaners, spray or pour any liquid, nor wipe any abrasive cleaner on the screen nor any surface of the unit. Do not use tissues or paper towels to clean the screen. They contain wood fibers and may scratch the surface.

### **How do I clean the View Anywhere display screen?**

- To clean the View Anywhere display screen, wipe it with a soft cloth (like the one supplied). If needed, clean with any alcohol-based product recommended for use on anti-reflective glass. Other cleaning products may leave a residue. Do not spray cleaners, spray or pour any liquid, nor wipe any abrasive cleaner on the screen nor any surface of the unit. Do not use tissues or paper towels to clean the screen. They contain wood fibers and may scratch the surface.

### **Will scratches affect the performance of the display or digitizer?**

- Our testing has not found appreciable loss of performance on a scratched display.

### **How sensitive is the screen to various elements?**

- As with any computer or electronic device, you should protect it from liquids, dirt and sand, other contaminants, and extreme heat.

### **Will any monitor, USB device, keyboard, or mouse work with the system?**

- If the device has a driver for Windows, it will work with the system. For a list of products that have been tested for Windows, go to the Windows Marketplace Tested Products page at [www.microsoft.com/whdc/hcl](http://www.microsoft.com/whdc/hcl).

### **Why is the tablet PC lacking USB and display adapter ports?**

- The tablet PC is designed to be easy to clean and disinfect, so ports and connectors are minimized.

## How do I adjust the system for left-handed use?

- Open the Tablet and Pen Settings window (page 22). You can select left- or right-handed and change the location of the menus. You should calibrate the pen if you change any pen options (page 6).

## Specifications

You can use System Information to find out more about your hardware and software environment. From the Start menu, choose **All Programs > Accessories > System Tools > System Information**.

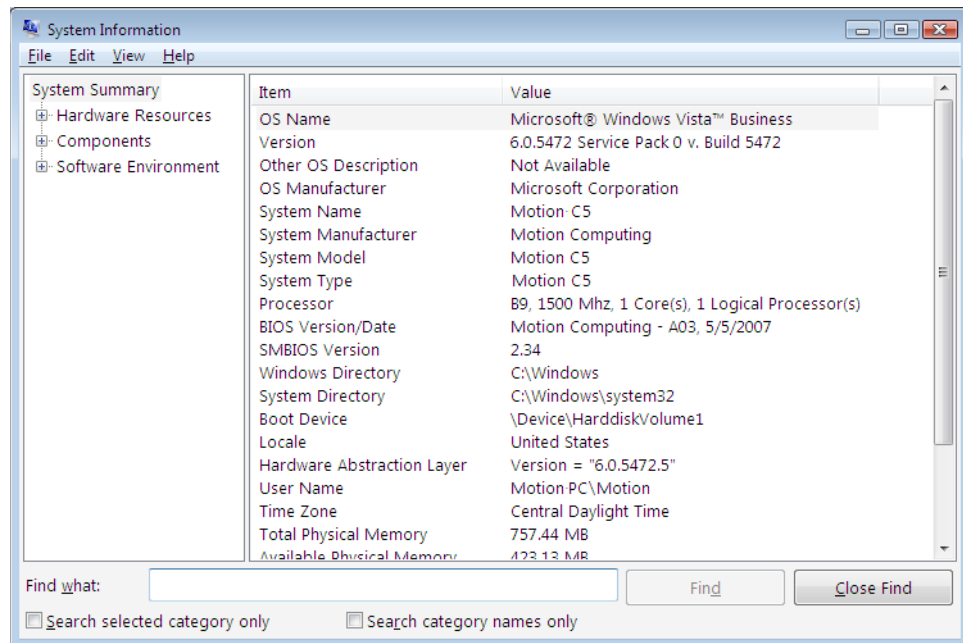

You can find the specifications for other Motion Computing products at [www.motioncomputing.com/products](http://www.motioncomputing.com/products).

## Warranty and insurance programs

Motion Computing currently provides limited warranties on Motion products and accessories. See the Warranty packaged with your Motion product or accessory or visit our Web site at [www.motioncomputing.com](http://www.motioncomputing.com).

In addition, Motion Computing offers extended warranties along with various screen and configuration insurance programs. Go to the Motion Computing Support and Services page at [www.motioncomputing.com/products/services\\_top.asp](http://www.motioncomputing.com/products/services_top.asp).



## Service and support

If you need help with your system, go to the Motion Computing Support and Services page at [www.motioncomputing.com/support](http://www.motioncomputing.com/support).

This page will provide you links to all the information you need about Motion products, technical support, customer services and professional services.



# Index

## Numerics

- 802.11a/b/g
  - about 17
  - enabling 39
  - setting up 40
  - using 39

## A

- AC adapter
  - about 18
  - using 5
- adjusting display brightness 25
- amber lights 10
- angle of acceptance
  - about 30
  - using 30
- Automatic Updates 53

## B

- backup procedure 63
- battery
  - about 18
  - checking status 34
  - gauge 34
  - notification area status 34
  - status light 10
  - swapping 36
  - tips 36
  - using 34
- BIOS
  - opening 54
  - setting a password 54
- blinking lights 10
- Bluetooth
  - about 17
  - discovery 46
  - enabling 44
  - setting up 44, 45
  - tips 47
  - using 44
- bookmarks, using 1
- buttons
  - about 11
  - configuring 24
  - functions 11

## C

- calibrating the digitizer 6
- calibrating the pen 6
- capturing a fingerprint 48
- care and maintenance
  - display 58
  - fingerprint reader 61
  - general care 57
  - pen 61
  - replacement pens 62
  - replacing pen tips 62
  - screen 58
  - View Anywhere display 58
- change the display orientation 25
- character pad 21
- charging the battery 35
- checking battery gauge 34
- checking battery status 34
- cleaning
  - display 58
  - fan cover 60
  - fingerprint reader 61
  - solutions 60
- configuring
  - front panel buttons 24
  - pen options 22, 23
  - rotation sequence 26
- cord 18
- Ctrl+Alt+Del 3, 13
- customizing buttons 24

## D

- Dashboard
  - starting 20
  - using 20
- Dashboard button
  - about 11
  - configuring 24
- DataGuard 14
- dictation mode 31
- digitizer pen
  - about 21
  - calibrating 6
- directional pad 2, 11

- disabling
  - the eraser 22
  - the pen button 22
- display
  - about 12
  - brightness 25
  - features 12
  - rotating 25
  - rotation sequence 26
  - using 25
- disposing of used batteries 37
- docking connector 16
- document, about 1
- dynamic brightness 25

## **E**

- enabling
  - 802.11a/b/g 39
  - Bluetooth 44
  - eraser 22
  - pen button 22
  - Wi-Fi 39
- eraser
  - about 21
  - enabling 22
- Esc button
  - configuring 24

## **F**

- FAA wireless air travel requirement 63
- features overview 9
- finding additional software 55
- fingerprint reader
  - about 13
  - setting up 48
  - tips 50
- five-way directional controller 2, 11
- fixed brightness 25
- flashing lights 10
- frequently asked questions 71
- front panel buttons
  - about 11
  - configuring 24
- front panel lights 10
- Function button
  - about 11
  - configuring 24

## **G**

- getting started 5

- green lights 10

## **H**

- handwriting recognition
  - about 21
  - using 21
- hardware overview 2, 9
- HDD password, setting up 54
- Hibernate
  - about 38, 39
  - using 38, 39

## **I**

- indicator lights 10
- Infineon Security Platform Tools 12
- Input Panel
  - using 21
- insurance 72
- integrated microphones 16, 30
- integrated speaker 16
- Internet Options 53

## **K**

- key button 13
- keyboard 21

## **L**

- landscape mode 25
- LCD
  - about 12
  - care and cleaning 58
  - View Anywhere 12
- Li-ion battery 18
- liquid crystal display *See* LCD
- Lithium-ion battery *See* Li-ion battery
- logging on to a remembered site 52

## **M**

- maintenance
  - backup 63
  - recovery 63
- maintenance procedures 57
- medium angle setting 30
- microphones
  - about 16
  - using 30
- mini-plug 18
- Motion Dashboard
  - using 20

Motion Dashboard button 11

## **N**

narrow angle setting 30  
networking  
    Bluetooth 17  
    wireless 17

## **O**

OmniPass  
    about 13, 48  
    starting 48  
on-screen keyboard 21  
ordering replacement pens 62  
overview  
    hardware 9  
    ports and connectors 2

## **P**

Page Down 11  
Page Up 11  
password replacement  
    about 51  
    using 51, 52  
pen  
    about 21  
    actions 21  
    calibrating 6  
    care and maintenance 61  
    configuring options 22, 23  
plug 18  
plugging in 5  
portrait mode 25  
power adapter  
    about 18  
    port 3  
    using 5  
power cord  
    about 18  
    using 5

## **R**

recovery procedure 63  
removing the battery 35  
replacing pen tips 62  
replacing the battery 35  
right-clicking 21  
rotate sequence 26  
rotate the display 25

rotating the display 25

## **S**

security  
    features 12  
    using 12  
service 73  
setting up 5  
    802.11a/b/g 40  
    a BIOS password 54  
    an HDD password 54  
    Bluetooth 44, 45  
    strong logon security 52  
    the fingerprint reader 48  
    users and passwords 53  
    Wi-Fi 40  
    Windows user accounts 53  
Shift+Tab 11  
skew angle 31  
Speak Anywhere 30  
speaker 16  
specifications 72  
speech recognition  
    about 31  
    setting up 32, 33  
Standby  
    about 38  
    using 38  
status lights 2, 10  
strong logon security  
    about 52  
    enabling 52  
support 73  
swapping batteries 36

## **T**

Tab key 11  
Tablet & Pen Settings 22, 23, 24  
Tablet PC Input Panel  
    using 21  
tablet PC tutorials 6  
Task Manager 67, 70  
TPM 12  
traveling 62  
troubleshooting  
    battery 68  
    display 68  
    input 69  
    network 70  
    system 70

Trusted Platform Module 12  
turning on the unit 5  
tutorials, Windows XP Tablet PC Edition 6

## **U**

using  
    802.11a/b/g 39  
    angle of acceptance 30  
    battery 34  
    Bluetooth 44  
    handwriting recognition 21  
    Hibernate 38, 39  
    Input Panel 21  
    microphones 30  
    OmniPass 48  
    power management 37  
    security 12  
    skew angle 31  
    speech recognition 31  
    Standby 38  
    this document 1  
    Wi-Fi 39

## **V**

View Anywhere display 12

voice commands 31

## **W**

warranty 72  
wide angle setting 30  
Wi-Fi  
    about 17  
    enabling 39  
    setting up 40  
    using 39  
Windows Firewall 53  
Windows Journal 11  
Windows Security button 13  
Windows Security Center  
    about 53  
    using 53  
Windows Vista  
    tutorials 6  
Windows XP Tablet PC Edition  
    about 6  
wireless  
    802.11a/b/g 17  
    Bluetooth 17  
wireless networking 17  
writing pad 21